

User manual INDICATOR SWS-W606

- Firmware: v.1.12 or higher
- Input type: RS-485
- Master / Slave function, large-size, 6 x 57 mm display



Read the user's manual carefully before starting to use the unit or software.
Producer reserves the right to implement changes without prior notice.

CONTENTS

1. BASIC REQUIREMENTS AND USER SAFETY	3
2. GENERAL CHARACTERISTICS	4
3. TECHNICAL DATA	4
4. DEVICE INSTALLATION	5
4.1. UNPACKING.....	5
4.2. ASSEMBLY.....	6
4.3. CONNECTION METHOD.....	7
4.4. MAINTENANCE.....	9
5. FRONT PANEL DESCRIPTION	9
6. PRINCIPLE OF OPERATION	10
6.1. DISPLAYING MODE.....	10
6.1.1. SLAVE mode operation.....	11
6.1.2. MASTER mode operation.....	11
7. DEVICE PROGRAMMING	11
7.1. PROGRAMMING MENU.....	11
7.2. PARAMETERS EDITION.....	12
7.2.1. Numeric parameters (digit change mode).....	12
7.2.2. Numeric parameters (slide change mode).....	12
7.2.3. Switch parameters ("LIST" type).....	13
7.3. MENU DESCRIPTION.....	13
7.3.1. "bri" parameter.....	13
7.3.2. "SLAv" menu.....	14
7.3.3. "mASt" menu.....	14
7.3.4. "rS" menu.....	15
7.3.5. "Scod" parameter.....	16
7.3.6. "Edit" parameter.....	17
7.3.7. "dEFS" parameter.....	17
7.3.8. "SErv" menu.....	17
7.4. MENU STRUCTURE.....	18
8. THE MODBUS PROTOCOL HANDLING	19
8.1. LIST OF REGISTERS.....	19
8.2. TRANSMISSION ERRORS DESCRIPTION.....	21
8.3. DRIVING OF DECADES.....	21
8.3.1. Decimal point position and minimal number of digits.....	22
8.3.2. Interpretation of registers 10h ... 15h content.....	22
8.3.3. Interpretation of registers 18h ... 1Dh content.....	23
8.3.4. Examples of exploration of registers 02h and 03h.....	23
8.3.5. Examples of exploration of registers 10h ... 15h.....	24
8.4. EXAMPLES OF QUERY/ANSWER FRAMES.....	25
9. DEFAULT AND USER'S SETTINGS LIST	27

Explanation of symbols used in the manual:



- This symbol denotes especially important guidelines concerning the installation and operation of the device. Not complying with the guidelines denoted by this symbol may cause an accident, damage or equipment destruction.

IF THE DEVICE IS NOT USED ACCORDING TO THE MANUAL THE USER IS RESPONSIBLE FOR POSSIBLE DAMAGES.



- This symbol denotes especially important characteristics of the unit. Read any information regarding this symbol carefully

1. BASIC REQUIREMENTS AND USER SAFETY



- **The manufacturer is not responsible for any damages caused by inappropriate installation, not maintaining the proper technical condition and using the unit against its destination.**
- Installation should be conducted by qualified personnel . During installation all available safety requirements should be considered. The fitter is responsible for executing the installation according to this manual, local safety and EMC regulations.
- GND input of device should be connected to PE wire;
- The unit must be properly set-up, according to the application. Incorrect configuration can cause defective operation, which can lead to unit damage or an accident.
- **If in the case of a defect of unit operation there is a risk of a serious threat to the safety of people or property additional, independent systems and solutions to prevent such a threat must be used.**
- **The unit must be switched off and disconnected from the power supply prior to starting installation of troubleshooting (in the case of malfunction).**
- Neighbouring and mating equipment must meet the requirements of appropriate standards and regulations concerning safety and be equipped with adequate anti-overvoltage and anti-interference filters.
- **Do not attempt to disassemble, repair or modify the unit yourself. The unit has no user serviceable parts. Units, in which a defect was stated must be disconnected and submitted for repairs at an authorized service centre.**



- In order to minimize fire or electric shock hazard, the unit must be protected against atmospheric precipitation and excessive humidity.



- Do not use the unit in areas threatened with excessive shocks, vibrations, dust, humidity, corrosive gasses and oils.
- Do not use the unit in areas where there is risk of explosions.
- Do not use the unit in areas with significant temperature variations, exposure to condensation or ice.
- Do not use the unit in areas exposed to direct sunlight.
- Make sure that the ambient temperature (e.g. inside the control box) does not exceed the recommended values. In such cases forced cooling of the unit must be considered (e.g. by using a ventilator).



The unit is designed for operation in an industrial environment and must not be used in a household environment or similar.

2. GENERAL CHARACTERISTICS

The **SWS-W606** is a simple digital panel indicator intended for displaying any numerical values and characters defined by user (in SLAVE mode only) sent from the master device over the RS 485 serial interface link. The displayed value may be collected from other device (in MASTER mode). User can change display brightness in 8 steps range.

The device is equipped with 4 buttons for main presets programming. To get high protection level, the keyboard is mounted under transparent cover.

To allow user to change presets without opening of cover, an IR sensor is mounted. Remote controller keyboard is equivalent to the device keyboard (Note, that remote controller is not a part of the **SWS-W606** set. It is an option.).

Modbus RTU protocol is used to communication with device. Baud rate is user defined in 1200 ÷ 115200 baud range. It is possible to order device with other communication protocol using RS-485 interface (special order required).

3. TECHNICAL DATA

Power supply voltage	12... 24 ...30V DC (stabilized)
External fuse (required)	T - type, max. 2 A
Power consumption	max. 5 W
Display range	numerical and alphanumeric messages possible to show on 7-segment display
Communication interface	RS 485, 8N1 and 8N2, Modbus RTU, not separated
Baud rate	1200 bit/s ÷ 115200 bit/s
Display	LED, 6 digits, 57 mm height, red, with 8-steps brightness regulation
Data memory	non-volatile memory, EEPROM type

Housing type	wall mounted
Housing material	steel St3 + methyl polymethacrylate
Housing dimensions	364 x 112 x 44 mm
Operating temperature (depending on version)	0°C to +50°C or -20°C to +50°C
Storage temperature (depending on version)	-10°C to +70°C or -20°C to +70°C
Humidity	5 to 90% no condensation
Altitude	up to 2000 meters above sea level
Screws tightening max. torque	0.5 Nm
Max. connection leads diameter	2.5 mm ²
EMC	according to: PN-EN 61326-1



This is a class A unit. In housing or a similar area it can cause radio frequency interference. In such cases the user can be requested to use appropriate preventive measures.

4. DEVICE INSTALLATION

The unit has been designed and manufactured in a way assuring a high level of user safety and resistance to interference occurring in a typical industrial environment. In order to take full advantage of these characteristics installation of the unit must be conducted correctly and according to the local regulations.



- Read the basic safety requirements on page 3 prior to starting the installation.
- Ensure that the power supply network voltage corresponds to the nominal voltage stated on the unit's identification label.
- The load must correspond to the requirements listed in the technical data.
- All installation works must be conducted with a disconnected power supply.
- Protecting the power supply clamps against unauthorized persons must be taken into consideration.

4.1. UNPACKING

After removing the unit from the protective packaging, check for transportation damage. Any transportation damage must be immediately reported to the carrier. Also, write down the unit serial number on the housing and report the damage to the manufacturer.

Attached with the unit please find:

- user's manual,
- warranty,

4.2. ASSEMBLY



- Disconnect the power supply prior to starting assembly.
- During installation all available safety requirements should be considered.
- The mounting method must to preserve high breaking strength, at least 4 times the mass of the device.
- Check the connections are wired correctly prior to switching the unit on.



To install the device two holes must be prepared (distance like in Figure 4.1) with screws or hooks. The device should be installed using its apertures placed on the back side of housing.

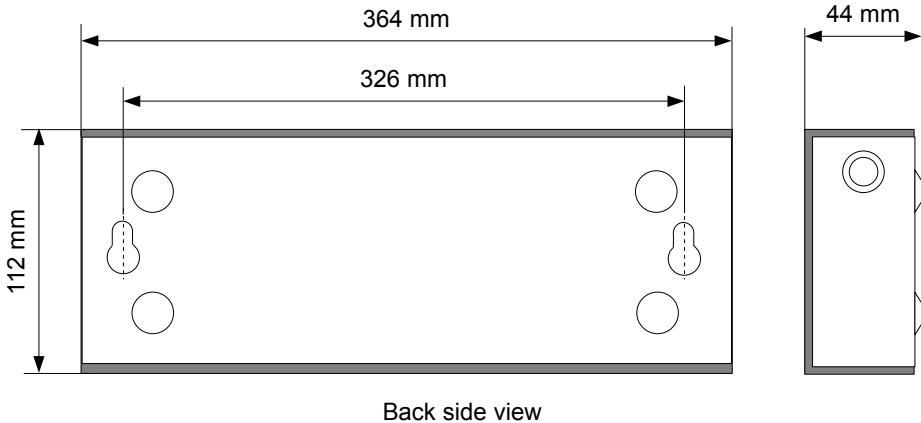

Figure 4.1. Device and assembly dimensions

4.3. CONNECTION METHOD

Caution



- Installation should be conducted by qualified personnel . During installation all available safety requirements should be considered. The fitter is responsible for executing the installation according to this manual, local safety and EMC regulations.
- The unit is not equipped with an internal fuse or power supply circuit breaker. Because of this an external time-delay cut-out fuse with minimal possible nominal current value must be used (recommended bipolar, max. 2A) and a power supply circuit-breaker located near the unit.
- The power supply network cable diameter must be selected in such a way that in the case of a short circuit of the cable from the side of the unit the cable shall be protected against destruction with an electrical installation fuse.
- Wiring must meet appropriate standards and local regulations and laws.
- In order to secure against accidental short circuit the connection cables must be terminated with appropriate insulated cable tips.
- Tighten the clamping screws. The recommended tightening torque is 0.5 Nm. Loose screws can cause fire or defective operation. Over tightening can lead to damaging the connections inside the units and breaking the thread.
- In the case of the unit being fitted with separable clamps they should be inserted into appropriate connectors in the unit, even if they are not used for any connections.
- **Unused clamps (marked as n.c.) must not be used for connecting any connecting cables (e.g. as bridges), because this can cause damage to the equipment or electric shock.**
- If the unit is equipped with housing, covers and sealing packing, protecting against water intrusion, pay special attention to their correct tightening or clamping. In the case of any doubt consider using additional preventive measures (covers, roofing, seals, etc.). Carelessly executed assembly can increase the risk of electric shock.
- After the installation is completed do not touch the unit's connections when it is switched on, because it carries the risk of electrical shock.

Due to possible significant interference in industrial installations appropriate measures assuring correct operation of the unit must be applied. To avoid the unit of improper indications keep recommendations listed below.

- Avoid common (parallel) leading of signal cables and transmission cables together with power supply cables and cables controlling induction loads (e.g. contactors). Such cables should cross at a right angle.
- Contactor coils and induction loads should be equipped with anti-interference protection systems, e.g. RC-type.

- Use of screened signal cables is recommended. Signal cable screens should be connected to the earthing only at one of the ends of the screened cable.
- In the case of magnetically induced interference the use of twisted couples of signal cables (so-called "spirals") is recommended. The spiral (best if shielded) must be used with RS-485 serial transmission connections.
- In the case of measurement or control signals are longer than 30m or go outside of the building then additional safety circuits are required.
- In the case of interference from the power supply side the use of appropriate anti-interference filters is recommended. Bear in mind that the connection between the filter and the unit should be as short as possible and the metal housing of the filter must be connected to the earthing with largest possible surface. The cables connected to the filter output must not run in parallel with cables with interference (e.g. circuits controlling relays or contactors).



Discharge hands, clothes tools and the device before opening the cover.

Connections of power supply voltage and control signals are executed using the screw connections on the left of the unit's housing.

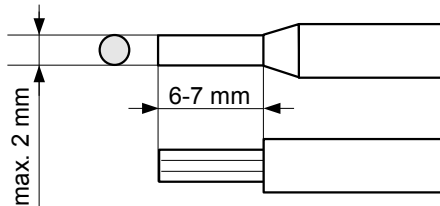

Figure 4.2. Method of cable insulation replacing and cable terminals

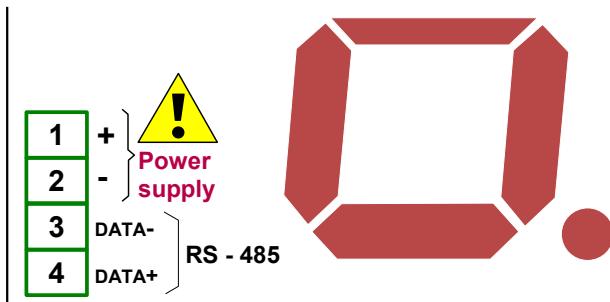

Figure 4.3. Terminals description



- All connections must be made while power supply is disconnected
- **After installation, power cord gland should be tighten up, to prevent cable move.**

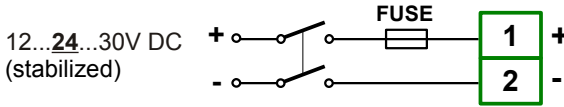

Figure 4.4. Connection of power supply

4.4. MAINTENANCE

The unit does not have any internal replaceable or adjustable components available to the user. Pay attention to the ambient temperature in the room where the unit is operating. Excessively high temperatures cause faster ageing of the internal components and shorten the fault-free time of unit operation.

In cases where the unit gets dirty do not clean with solvents. For cleaning use soft, dry cloth. In the case of more significant contamination use warm water with small amount of detergent to wet the cloth.



Using any other agents can cause permanent damage to the housing.



Product marked with this symbol should not be placed in municipal waste. Please check local regulations for disposal and electronic products.

5. FRONT PANEL DESCRIPTION

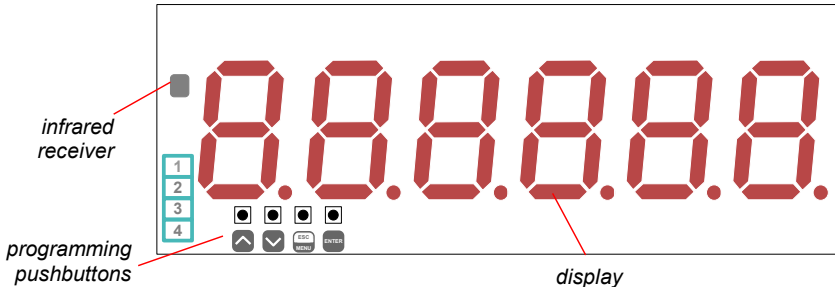

Symbols and functions of push-buttons:

Symbol used in the manual: **[ESC/MENU]**

Functions:

- Enter to main menu (press and hold by at least 2 sec.)
- Exit the current level and Enter to previous menu (or displaying mode)
- Cancel the changes made in parameter being edited



Symbol used in the manual: **[ENTER]**

Functions:

- Start to edit the parameter
- Enter to the sub-menu,
- Confirmation of changes made in parameter being edited



Symbol used in the manual: **[^] [v]**

Functions:

- Change of the present menu,
- Modification of the parameter value,
- Change of the display mode.

Inactive.

**6. PRINCIPLE OF OPERATION**

After turning the power supply on, device ID and software version are showed on the display, next the digital indicator goes to the display mode.

6.1. DISPLAYING MODE

Directly after enter to displaying mode, device displays “- - -” info as long as first actualization of displayed value via RS-485 interface comes. Depend on value of “**mode**” parameter of “**rS**” menu, device can works as MASTER or SLAVE. In SLAVE mode displayed value, and it's parameters are determined by values written to internal registers by other MASTER. In MASTER mode device reads values to displaying, and it's decimal point position from selected SLAVE device.

If content of displayed value register exceeds **permissible displaying range** following message is showed:

- “**ovH**” - if content displayed value register exceeds upper border of of **permissible displaying range**
- “**ovL**” - if content displayed value register is smaller than lower border of **permissible displaying range**

Permissible displaying range depends on number of available decades and equals:

- -999 ÷ 9999 for devices equipped with 4 decades,
- -99999 ÷ 999999 for devices equipped with 6 decades.

All accessible parameters can be changed by entering the menu (see: **DEVICE PROGRAMMING**). Use the local keyboard or the remote controller to do it. (Note: all parameters can be remote changed via RS-485 interface).



Configuration of the device (via menu or RS 485 interface) **do not stops device.**

6.1.1. SLAVE mode operation

In SLAVE mode device displays “- - - -” info as long as first write to displayed value registers by MASTER device comes over RS-485 interface. If new value will not be written in this register in time defined by “**mbtO**” parameter since last writing, currently displayed value starts blinking. It stops blinking after next proper write. SLAVE mode allows display user defined signs on selected positions (see: **DRIVING OF DECADES**, page 21). Parameters connected with SLAVE mode are accessible in menu “**SLAv**”, which is displayed only if SLAVE mode is selected (see “**modE**” parameter in “**rS**” menu).

6.1.2. MASTER mode operation

In MASTER mode device displays “- - - -” info as long as first read of selected registers of SLAVE device occurs. If SLAVE device do not responds during time defined by “**mbtO**” parameter, since MASTER sent last frame, currently displayed value starts to blinking. Blinking stops after next proper read of selected register of SLAVE device. Registers of SLAVE device are read every time defined by parameter “**PEr**”. Parameters connected with MASTER are accessible in menu “**mASt**”, which is displayed only if MASTER mode is selected (see “**modE**” parameter in “**rS**” menu).

7. DEVICE PROGRAMMING

The device menu allow user to set all parameters connected to operation of the display, control modes, communication via RS-485 and access settings. The meaning of the particular parameters is described in paragraph **MENU DESCRIPTION**.

7.1. PROGRAMMING MENU

To enter main menu (being in the displaying mode) operator must to press and hold at least 2 sec. [**ESC/MENU**] button.

If the user password is defined (see parameter “**Scod**“), operator have to enter correct one before proceeding to menu options . Entering of the passwords is similar to the edition of numeric parameters (see: **PARAMETERS EDITION**), however presently editing digit is showed only on the display, other digits are replaced by “-” sign.

After entering of last digit of the password first menu position will be displayed (if the password is correct) or warning “**Err**” in other case.

Functions of the buttons while sub-menu and parameters choice:

Selection of sub-menu or parameter for editing. Name of selected item (sub-menu or parameter) is displayed.



Operation of **[ENTER]** button depend on present menu position:

- if the name of some sub-menu is displayed - enter this sub-menu; name of the first parameter (or next level sub-menu) is displayed,
- if the name of some parameter is displayed - enter the edition of this parameter; present value of the parameter is displayed,



[ESC/MENU] button allow user to exit present menu level and goes to upper level menu (or displaying mode).



After about 1 min. since last use of the buttons, device exits the menu mode and returns to the displaying mode (only if no parameters are in editing mode).

7.2. PARAMETERS EDITION

To start edition of any parameter user should select name of desired one using **[^]** **[v]** buttons and then press **[ENTER]**.

7.2.1. Numeric parameters (digit change mode)

Numerical parameters are displayed as decimal numbers. The mode of its new value entering depends on chosen edit method (see parameter „**Edit**“).

In mode “by digit” („**Edit**“=“**dig**“) pressing one of the keys **[^]** or **[v]** causes change of current position (flashing digit) or the sign (+/-). Short pressing of the **[ENTER]** button causes change of the position (digit).

Press **[ENTER]** at least 2 seconds to accept the changes, after that question “**Set?**” is displayed, and user must to confirm (or cancel) the changes. To conform changes (and store it in EEPROM) press **[ENTER]** button shortly after “**Set?**” is displayed. To cancel the changes press **[ESC]** button shortly after “**Set?**” is displayed. After that device returns to the menu.

7.2.2. Numeric parameters (slide change mode)

In “slide change” mode („**Edit**“=“**Slid**“), buttons **[^]** and **[v]** has different functions.

To increase edited value press (or press and hold) **[^]** button only, the increasing became quickest as long as button **[^]** is pressed. To slow down the increasing, button **[v]** can be used. If **[v]** is pressed shortly (and button **[^]** is still pressed), increasing slow down for a moment only, if **[v]** is pressed and held while button **[^]** is still pressed the increasing slow down and will be kept on lower speed.

To decrease edited value press (or press and hold) **[v]** button only. The decreasing became quickest as long as button **[v]** is pressed. To slow down the decreasing, button **[^]** can be used. If **[^]** is pressed shortly (and button **[v]** is still pressed), decreasing slow down for a moment only, if **[^]** is pressed and held while button **[v]** is still pressed the decreasing slow down and will be kept on lower speed.

Press **[ENTER]** at least 2 seconds to accept the changes, after that question “**Set?**” is displayed, and user must to confirm (or cancel) the changes. To conform changes (and store it in EEPROM) press **[ENTER]** button shortly after “**Set?**” is displayed. To cancel the changes press **[ESC]** button shortly after “**Set?**” is displayed. After that device returns to the menu.

7.2.3. Switch parameters (“LIST” type)

Switch parameters can be described as a sets of values (a lists) out of which only one of the options available on the list can be selected for the given parameter. Options of switching parameter are selected using [^], [v] keys.

Short pressing of [ENTER] causes in displaying of the acknowledge question (“SEt?”). If key [ENTER] is pressed again, the changes are accepted, stored in EEPROM end the edition process finished. Pressing the key [ESC] after ”SEt?” causes in cancelling of made changes and returning to menu.

Functions of buttons when editing numeric and switching parameters:



While editing numeric parameter:

- change of current (flashing) digit
- slide change of value (acceleration, deceleration, direction change)

While editing switch parameter - selection of switch parameter.



If numerical parameter is being edited, a short press of [ENTER] button change edited position. A long press of [ENTER] button (at least 2 sec.) causes of display a ”SEt?” ask, which allow user to make sure if change of the parameter value is correct. If switch parameter is being edited, a short press of [ENTER] button causes of display a ”SEt?” ask. When [ENTER] button is pressed again (while ”SEt?” is displayed) the new value of the parameter is stored in EEPROM memory.



Pressing this button operator can cancel the changes done up to now (if they were not approved by [ENTER] button after the ”SEt?” ask) and come back to menu

7.3. MENU DESCRIPTION

“- . . . -”

- password checking. If some password different from „0000” is set, then every enter to main menu follows the entering of password. If entered password is correct then first menu position will be displayed else warning ”Err”, and unit returns to displaying mode.



Due to problem with direct displaying of “m” letter, it is exchanged with special sign “ \bar{m} ”. Independently in user manual letter „m” is used to make it more readable (example: “modE”).

7.3.1. ”bri” parameter

This parameter allows user to set bright of the LED display, bright can be set to conventional values from “bri1” to “bri8”.

7.3.2. "SLAv" menu

This menu is accessible only if SLAVE mode is selected, and it contains parameters connected with this mode:

"Addr" - this parameter defines the address of the device, accordingly to Modbus protocol. It can be set in range from 0 to 199. If the value 0 is set then device, responds to frames with address 255 (FFh).



In SLAVE mode every **SWS-W606** connected to the same serial network should have its own address, different from other devices addressed.

"tyPE" - type of value written to displayed value registers, it can be set to:

- "U-16"** - unsigned 16 bit (write to register 01h is not necessary);
- "S-16"** - signed 16 bit (write to register 01h is not necessary);
- "U-32"** - unsigned 32 bit (writes to registers 01h and 02h are necessary);
- "S-32"** - signed 32 bit (writes to registers 01h and 02h are necessary);

"mbAc" - this parameter sets the access to the configuration registers of the device. Possible values:

- "on"** - configuration registers can be set via RS-485 interface,
- "oFF"** - configuration registers can not be set via RS-485 interface.



Blockade of writing do not refers with registers no. 01h, 02h i 03h (see: **LIST OF REGISTERS**).

"vALr" - this parameter defines reaction for writes to registers 01h, 02h and 03h, it can be set to:

- "on"** - after writes device responds with standard frame
- "oFF"** - after writes device do not sends anything.



If parameter **"vALr"** is set to **"oFF"**, then it is possible to drive many devices simultaneously (at the same moments), without collisions in network.

7.3.3. "mASt" menu

This menu is accessible only if MASTER mode is selected, and it contains parameters connected with this mode:

- "Addr"** - this parameter defines the address of the device which have to be read. It can be set in range from 0 to 199. If the value 0 is set then device with address 255 (FFh) will be read.
- "rEG"** - this parameter defines holding register number (of SLAVE device), which contains displayed value. If displayed value type is set as 32 bits (signed or unsigned – see parameter **"tYPE"**, parameter **"rEG"** defines higher word register address. Its value can be changed from 0 to 9999.
- "tYPE"** - type of value written to displayed value registers, it can be set to:
- "U-16"** - unsigned 16 bit (single register);
 - "S-16"** - signed 16 bit (single register);
 - "U-32"** - unsigned 32 bit (two following registers);
 - "S-32"** - signed 32 bit (two following registers);
- "Pnt"** - decimal point position, following values are possible for this parameter
" 0", " 0.0", " 0.00", ..., "rEG".
If value **"rEG"** is selected, then decimal point position will be read from holding register defined by parameter **"PrEG"** of SLAVE device defined by parameter **"Addr"**
- "PrEG"** - this parameter defines holding register number (of SLAVE device) which contains decimal point position. Value of this parameter matters only if parameter **"Pnt"** is set to value **"rEG"**. In other case value of **"PrEG"** does not matter.
- "PER"** - this parameter defines time period between successive reads of displayed value and decimal point position (if **"Pnt"**="rEG") registers.

7.3.4. "rS" menu

This menu is connected with RS-485 interface, and sets his properties:

- "modE"** - this parameter defines device operation mode. There are available two modes:
- "mASt"** - MASTER mode operation. **SWS-W606** unit reads necessary data from defined registers of SLAVE device. All parameters referred with this operation mode are available in **"mASt"** submenu;
 - "SLAv"** - SLAVE mode operation, **SWS-W606** unit waits for data from MASTER device. All parameters referred with this operation mode are available in **"SLAv"** submenu;
- "bAud"** - this parameter determines RS-485 interface baud rate. It can be set to one of 8 possible values: **"1.2"**, **"2.4"**, **"4.8"**, **"9.6"**, **"19.2"**, **"38.4"**, **"57.6"**, **"115.2"**, which respond to the baud rates of 1200, 2400, 4800, 9600, 19200, 38400, 57600 and 115200 bit/s respectively.

"mbtO" - this parameter defines maximal time (sec) between following frames received by the device. If the delay will be greater than the value of **"mbtO"** parameter, displayed value starts blinking. Parameter **"mbtO"** can be set to values from 0 to 99 seconds. The value 0 means that the time will be not controlled.



In MASTER mode, time period defined by parameter **"mbtO"** is prolonged of value defined by parameter **"PEr"**.

"rESP" - this parameter defines minimal (additional) delay between the Modbus message and the answer of the device (received and sent via RS-485 interface). This additional delay allows the device to work with poor RS-converters which do not works properly on baud rates higher than 19200. This parameter can be set to one of values:

"Std" - answer as quick as possible, no additional delay

"10c"

"20c"

"50c"

"100c"

"200c"

- answer delayed of 10, 20, 50, 100 of 200 chars respectively, where one character time depends on selected baud rate



In the most cases parameter **"rESP"** should be set to **"Std"** (no additional delay). Unfortunately for some third party RS-converters **"rESP"** should be adjusted experimentally. Table 7.1 contains most frequently used values.

"bAud" parameter	"38.4"	"57.6"	"115.2"
"rESP" parameter	"10c"	"20c"	"50c"

Tab.7.1. Settings of **"rESP"** parameter

7.3.5. **"Scod" parameter**

This parameter defines user password (4-digits number). If this parameter is set at value **"0000"**, user password is turned off.

If the user do not remember his password, the access to the menu is possible by the "one-use password". To get this password please contact with Marketing Division. "Single use password" can be used only one time, after that it is destroyed. Entering this password causes in clearing of user password, it means sets the user password to „0000“.



The "one-use password" can be used **ONE TIME ONLY**, it is impossible to use it again! The "one-use password" can be restored by Service Division only.

7.3.6. "Edit" parameter

This parameter allows to change the edition mode of numerical parameters:

- "dig"** - the change to "by digit" mode,
- "Slid"** - slide change mode.

7.3.7. "dEFS" parameter

This setting allows to restore the factory settings of the device. To get the access to this option special password is required: „5465“, next the device displays acknowledge question „SEt?“. Press **[ENTER]** to acknowledge the restoring of factory settings or **[ESC]** to cancel.

7.3.8. "SErv" menu

This menu contains the parameters for authorized service only. To enter this menu proper service password must be entered. Improper settings can causes of damage of the device.

7.4. MENU STRUCTURE

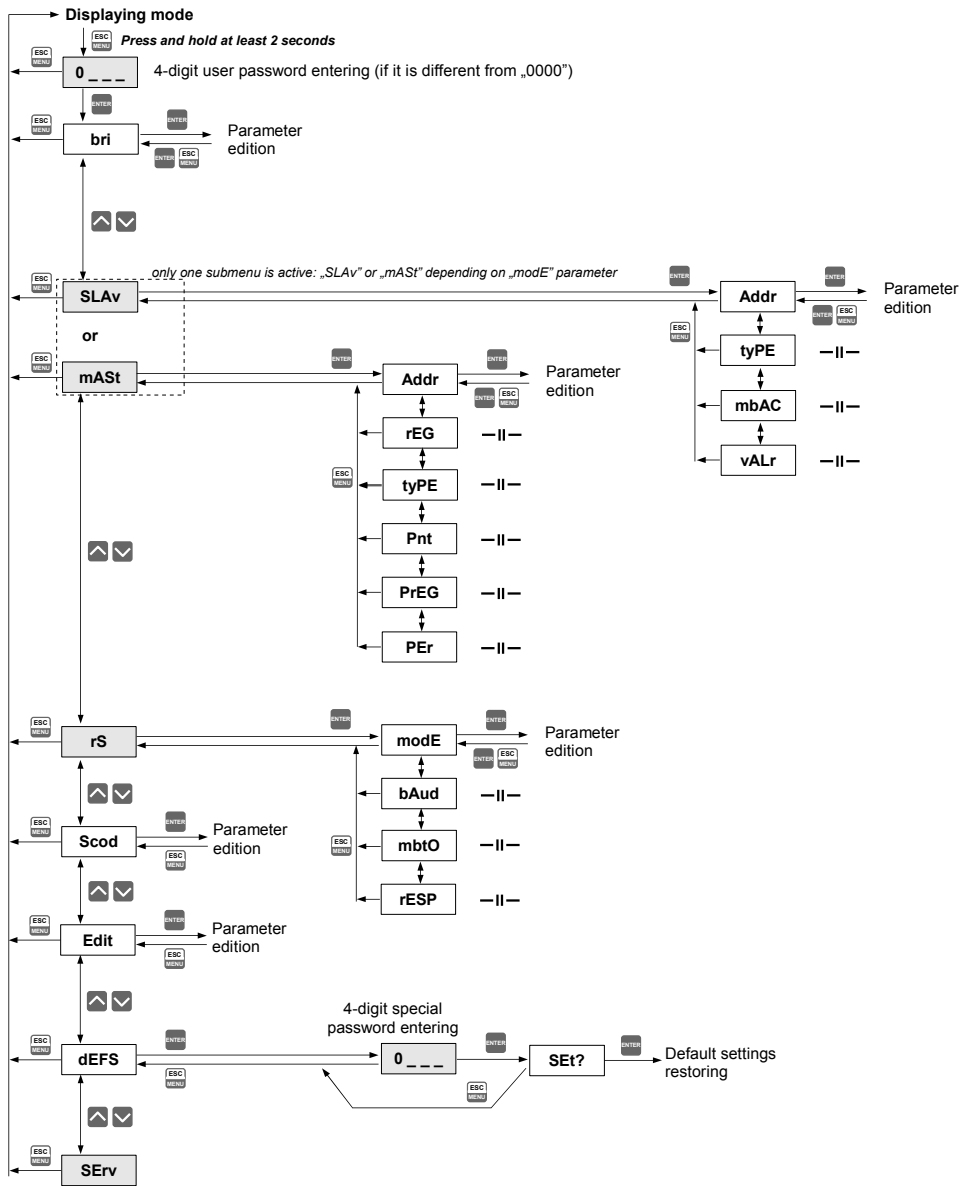

8. THE MODBUS PROTOCOL HANDLING

Transmission parameters: 1 start bit, 8 data bits, 1 or 2 stop bit (2 bits are send, 1 and 2 bits are accepted when receive), no parity control
 Baud rate: selectable from: 1200 to 115200 bits/second
 Transmission protocol: MODBUS RTU compatible

The device parameters and display value are available via RS-485 interface, as HOLDING-type registers (numeric values are given in U2 code) of Modbus RTU protocol. The registers (or groups of the registers) can be read by 03h function, and wrote by 06h (single registers) or 10h (group of the registers) accordingly to Modbus RTU specification. Maximum group size for 03h and 10h functions can not exceeds 16 registers (for single frame).



The device interprets the broadcast messages, but then do not sends the answers.

8.1. LIST OF REGISTERS

Register	Write	Range	Register description
01h	Yes	see descr.	Displayed value – higher word.
02h	Yes		<p>Warning! To change displayed value it is required to write data in following manner: first higher word and next lower word of data. Writing of higher word only do not causes changes in displayed data.</p> <p>Displayed value - lower word. Total value of registers 01h and 02h: from -99999 to 999999; data type depends on parameter “tyPE” of “SLAV” submenu.</p>
03h	Yes	see descr.	<p>Higher byte – displaying mode of registers 01h i 02h content: 00h – display value of registers 01h i 02h as a digits, with control of range. If allowable range from -99999 to 999999 is exceeded then proper warning is displayed (“ovH” or “ovL”); 80h – display “-Hi-” rather than value of registers 01h i 02h; 40h – display “-Lo-” rather than value of registers 01h i 02h;</p> <p>Lower byte: bit 7 - reserved bits 6..4 - minimal number of displayed digits. 0 – one digit; 1 – two digits; etc. (see Tab. 8.1). If content of registers 01h and 02h is shorter than minimal number of digits, then additional 0's are displayed. bit 3 - display decimal point on most right position regardless of bits 2..0 value bits 2..0 – decimal point position: 0 – no decimal point; 1 - “ 0.0”; 2 - “ 0.00”; etc.</p>
04h	Yes	see descr.	<p>Lower byte – shift of displayed value to the left of the display - bits 3..0 defines shift size (0 – no shift; 1 – one position; etc.)</p>

Register	Write	Range	Register description
10h	Yes	see descr.	Lower byte: Sign defined for decade no. 1 (most right) (see Tab. 8.2); in ASCII mode – its value select sign of ASCII table; in bit mode: bit 0 - segment A,... bit 6 - segment G, bit 7 – DP, Higher byte: bit 7 – enable displaying of defined sign in place of digit of decade 1; bit 6 – ASCII coding enable other bits - reserved
11h	Yes	see descr.	Like above, but refers to decade 2
12h	Yes	see descr.	Like above, but refers to decade 3
13h	Yes	see descr.	Like above, but refers to decade 4
14h	Yes	see descr.	Like above, but refers to decade 5
15h	Yes	see descr.	Like above, but refers to decade 6
18h	Yes	see descr.	Attributes of decade 1 (most right , see Tab. 8.3); bit 12 – blinking enable (about 1Hz) other bits - reserved
19h	Yes	see descr.	Like above, but refers to decade 2
1Ah	Yes	see descr.	Like above, but refers to decade 3
1Bh	Yes	see descr.	Like above, but refers to decade 4
1Ch	Yes	see descr.	Like above, but refers to decade 5
1Dh	Yes	see descr.	Like above, but refers to decade 6
20h ¹	Yes	01h÷FFh	Device address in SLAVE mode.
21h	No	21EFh	Device identification code
22h ²	Yes	0÷7	“ bAud ” parameter in “ rS ” menu (baud rate); 0 - 1200 baud; 1 - 2400 baud; 2 - 4800 baud; 3 - 9600 baud; 4 - 19200 baud; 5 - 38400 baud; 6 - 57600 baud; 7 - 115200 baud
23h ³	Yes	0 ÷ 1	“ mbAc ” parameter in “ SLAv ” menu (permission to write registers via RS-485 interface); 0 - write denied ; 1 - write allowed
25h	Yes	0 ÷ 5	“ rESP ” parameter in “ rS ” menu (additional response delay); 0 - no additional delay; 1 - “ 10c ” option; 2 - “ 20c ” option; 3 - “ 50c ” option; 4 - “ 100c ” option; 5 - “ 200c ” option;
26h	Yes	0 ÷ 1	“ vALr ” parameter in “ SLAv ” menu (blockade of modbus answer , after writes to registers 01h, 02h or 03h); 0 – answer blocked; 1 – standard modbus answer
27h	Yes	0 ÷ 99	“ mbtO ” parameter in “ rS ” menu (maximum delay between received frames); 0 - no delay checking; 1 ÷ 99 - maximum delay expressed in seconds
2Dh ⁴	Yes	1 ÷ 8	“ bri ” parameter (display brightness); 1 - the lowest brightness; 8 - the highest brightness
2Fh	Yes	0 ÷ 1	“ Edit ” parameter (numerical parameters edit mode); 0 - „ dig ” mode; 1 - „ SLid ” mode

Register	Write	Range	Register description
30h	Yes	0 ÷ 3	“type” parameter in “SLAV” menu (displayed value type): 0 - unsigned 16 bit (write to register 01h is not necessary); 1 - signed 16 bit (write to register 01h is not necessary); 2 - unsigned 32 bit (writes to registers 01h and 02h are necessary); 3 - signed 32 bit (writes to registers 01h and 02h are necessary);
31h ⁴	Yes	1 ÷ 8	Dynamically driving of display brightness via serial interface

- 1 - after writing to register no 20h the device responds with an “old” address in the message.
- 2 - after writing to register no 22h the device responds with the new baud rate.
- 3 - the value of the “mbAc” parameter is also connected to write to this register, so it is possible to block a writes, but impossible to unblock writes via RS-485 interface, The unblocking of the writes is possible from menu level only.
- 4 - if often changing of display brightness is required, writing to register 31h is recommended. Contents of this register is not stored while power off, and after power on parameter set via MENU is used for display brightness (register 2Dh)

8.2. TRANSMISSION ERRORS DESCRIPTION

If an error occurs while write or read of single register, then the device sends an error code according to Modbus RTU specifications.

Error codes:

- 01h** - illegal function (only functions 03h, 06h and 10h are available),
- 02h** - illegal register address
- 03h** - illegal data value
- 08h** - no write permission (see: “mbAc” parameter)

8.3. DRIVING OF DECADES



- Driving of decades described below is possible in SLAVE mode only
- Number of available decades depends on device type

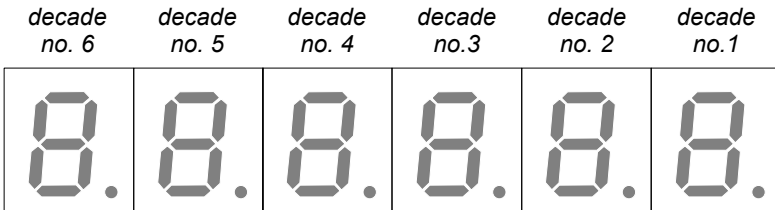

Figure 8.1. Decades positions for 6 decade version

8.3.1. Decimal point position and minimal number of digits

Bits 6..0 of register. 03h (example value)	Displayed message if „displayed value” equals 1	Displayed message if „displayed value” equals 123
000 0000	1	123
000 0001	0.1	12.3
000 0010	0.01	1.23
000 0011	0.001	0.123
000 1xxx	1.	123.
010 0000	01	123
010 0001	0.1	12.3
010 0010	0.01	1.23
010 1xxx	01.	123.
100 0000	0001	0123
100 0001	000.1	012.3
100 0010	00.01	01.23
100 1xxx	0001.	0123.

x - does not matter

Tab. 8.1. Decimal point position and minimal number of digits

8.3.2. Interpretation of registers 10h ...15h content

- Con** - if this bit is set (1) then, sign defined by bits **7..0** is displayed in place of particular digit (defined as a part of registers 01h and 02h value),
- Asc** - if this bit is set then sign to be placed on particular decade (defined by bits **7..0**) is interpreted as ASCII code,
- X** - these bits does not matter
- DP, G...A** - these bits defines if particular segments light or not (only if bit **Asc=0**) or ASCII code of particular decade (only if bit **Asc=1**).

15	14	13..8	7	6	5	4	3	2	1	0
Con	Asc	X	DP	G	F	E	D	C	B	A

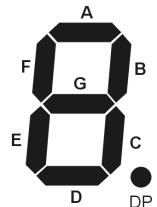

Tab. 8.2. Interpretation of registers 10h ...15h content

8.3.3. Interpretation of registers 18h ... 1Dh content

- X** - these bits does not matter
- BL** - if this bit is set then particular decade blinks about time per second

15..13	12	11..0
X	BL	X

Tab. 8.3. Interpretation of registers 18h ... 1Dh content

8.3.4. Examples of exploration of registers 02h and 03h

To display 16 bit signet numbers, with 2 digits after decimal point. Parameter "tyPE" of menu "SLAV" should be set to "S-16" (16 bit signed values). To set decimal point position, the value of register 03h must to be written with value 2 (see Tab. 8.1). Decimal point position can be done once, and it is valid for all further values of reg. 01h and 02h.

To set displayed value, its value must to be written to register 01h and 02h, e.g.

- by writing of 0010h (+16 decimal) to register 02h (reg. 01H =0000h) causes by displaying:



- by writing values higher than **permissible displaying range** causes by displaying:

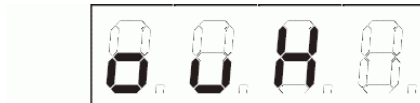

- by writing values lower than **permissible displaying range** causes by displaying:

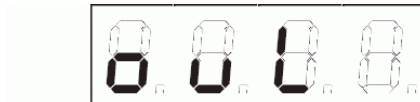



Displaying of negative numbers is possible only if proper displaying value data type is selected („S-32” or „S-16”). Negative values should be written in U2 code.

8.3.5. Examples of exploration of registers 10h ... 15h

To display message like showed hereafter, with assumption that number value (6.5) may be changed (e.g. depend on measurement value):



User should set:

1. register 02h to value 0021h (65 decimal)
2. register 03h (decimal point position) to value 0001h (see Tab. 8.1),
3. register 10h (sign in place of decade 1) to value C043h (ASCII code of „C” sign in lower byte and bits **Con** i **Asc** in higher byte, see Tab. 8.2),
4. register 11h (sign in place of decade 2) to value 8063h (byte code of „°” sign in lower byte, and bit **Con** in higher byte – no ASCII coding - see Tab. 8.2),
5. register 04h (left shift of displayed value) to value 02h (shift of 2 positions to the left).

Writes presented above can be done at once, and it is valid for all further values of reg. 01h and 02h.

To change displayed number (6.5) it is change of register 02h only is necessary (if data type is set to 16 bits), e.g. By writing of value 12 to reg. 02h causes by displaying message:



User must to remember, that signs defined by registers 10h...13h will be displayed in place of particular digits of displayed values, e.g. If in example above user writes value C041h (sign „A” in ASCII code) to register 12h, then device shows message:



8.4. EXAMPLES OF QUERY/ANSWER FRAMES

Examples apply for device with address 1. All values are represent hexadecimal.

Field description:

ADDR	Device address on modbus network
FUNC	Function code
REG H,L	Starting address (address of first register to read/write, Hi and Lo byte)
COUNT H,L	No. of registers to read/write (Hi and Lo byte)
BYTE C	Data byte count in answer frame
DATA H,L	Data byte (Hi and Lo byte)
CRC L,H	CRC error check (Hi and Lo byte)

1. Read of device ID code

ADDR	FUNC	REG H,L		COUNT H,L		CRC L,H	
01	03	00	21	00	01	D4	00

The answer:

ADDR	FUNC	BYTE C	DATA H,L		CRC L,H	
01	03	02	21	EF	E1	98

DATA - identification code (21EFh)

2. Change of the device address from 1 to 2 (write to reg. 20h)

ADDR	FUNC	REG H,L		DATA H,L		CRC L,H	
01	06	00	20	00	02	09	C1

DATA H - 0

DATA L - new device address (2)

The answer (the same as the message):

ADDR	FUNC	REG H,L		DATA H,L		CRC L,H	
01	06	00	20	00	02	09	C1

3. Writing of value to be displayed, and decimal point position (multi register write using modbus function 10h)

ADDR	FUNC	REG H,L		COUNT H,L		BYTE C
01	10	00	01	00	03	06

And next bytes of frame:

DATA H1,L1		DATA H2,L2		DATA H3,L3		CRC L,H	
00	00	04	D2	00	02	97	8D

This write causes by displaying message: **"12.34"**

Device's answer:

ADDR	FUNC	REG H,L		COUNT H,L		CRC L,H	
01	10	00	01	00	03	D1	C8

4. Try to write improper value to register 22h (baud rate).

ADDR	FUNC	REG H,L		DATA H,L		CRC L,H	
01	06	00	22	00	09	E9	C6

DATA L - DATA L – value exceeds allowable range (from 0 to 7)

The answer (if an error occur):

ADDR	FUNC	ERR	CRC L,H	
01	86	03	02	61



There is no full implementation of the Modbus Protocol in the device. The functions presented above are available only.

9. DEFAULT AND USER'S SETTINGS LIST

<i>Parameter</i>	<i>Description</i>	<i>Default value</i>	<i>User's value</i>	<i>Desc. page</i>
bri	Display brightness	bri6		13
Configuration of SLAVE mode (menu "SLAv")				
Addr	SWS-W606 device address	0		14
tyPE	Display value type	S-16		14
mbAC	Permission to changes of configuration registers	on		14
vALr	Blockade of answer after writes to reg. 01H , 02h or 03h	on		14
Configuration of MASTER mode ("mASt" menu)				
Addr	SLAVE device address	0		15
rEG	Number of displayed value register	1		15
tyPE	Displayed value data type	S-16		15
Pnt	Decimal point position	0		15
PrEG	Decimal point register number (of SLAVE device)	5		15
PEr	Time period of data reading from SLAVE device	0		15
RS 485 interface configuration ("rS" menu)				
modE	Operation mode	SLAv		15
bAud	Baud rate	9600		15
mbtO	Maximum delay between received messages	0		16
rESP	Additional delay of answer transmission	Std		16
Configuration of numerical parameters edition				
Edit	Numerical parameters edit mode	dig		17

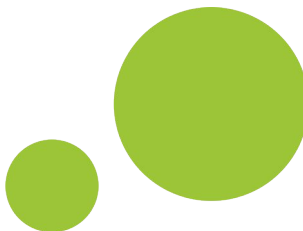

**SIMEX Sp. z o.o.
ul. Wielopole 7
80-556 Gdańsk
Poland**

**tel.: (+48 58) 762-07-77
fax: (+48 58) 762-07-70**

**<http://www.simex.pl>
e-mail: info@simex.pl**