

User manual MODULE SOC-8

- Firmware: v.2.0 or higher
- Input type: voltage OC
- Dedicated for DAQ systems

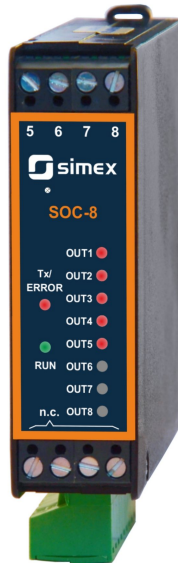

Read the user's manual carefully before starting to use the unit or software.
Producer reserves the right to implement changes without prior notice.

CONTENTS

1. BASIC REQUIREMENTS AND USER SAFETY.....	3
2. GENERAL CHARACTERISTICS.....	3
3. TECHNICAL DATA.....	3
4. DEVICE INSTALLATION.....	4
4.1. UNPACKING.....	5
4.2. CONNECTION METHOD.....	5
4.3. MAINTENANCE.....	8
5. PRINCIPLE OF OPERATION.....	8
5.1. EXAMPLES OF OUTPUT CONTROLLING.....	9
6. THE MODBUS PROTOCOL HANDLING.....	10
6.1. LIST OF REGISTERS.....	10
6.2. TRANSMISSION ERRORS DESCRIPTION.....	11
6.3. EXAMPLES OF QUERY/ANSWER FRAMES.....	11

Explanation of symbols used in the manual:



- This symbol denotes especially important guidelines concerning the installation and operation of the device. Not complying with the guidelines denoted by this symbol may cause an accident, damage or equipment destruction.

IF THE DEVICE IS NOT USED ACCORDING TO THE MANUAL THE USER IS RESPONSIBLE FOR POSSIBLE DAMAGES.



- This symbol denotes especially important characteristics of the unit. Read any information regarding this symbol carefully

1. BASIC REQUIREMENTS AND USER SAFETY



- **The manufacturer is not responsible for any damages caused by inappropriate installation, not maintaining the proper environmental conditions and using the unit contrary to its assignment.**
- Installation should be conducted by qualified personnel . During installation all available safety requirements should be considered. The fitter is responsible for executing the installation according to this manual, local safety and EMC regulations.
- The unit must be properly set-up, according to the application. Incorrect configuration can cause defective operation, which can lead to unit damage or an accident.
- **If in the case of a unit malfunction there is a risk of a serious threat to the safety of people or property additional, independent systems and solutions to prevent such a threat must be used.**
- Neighbouring and connected equipment must meet the appropriate standards and regulations concerning safety and be equipped with adequate overvoltage and interference filters.
- **Do not attempt to disassemble, repair or modify the unit yourself. The unit has no user serviceable parts. Defective units must be disconnected and submitted for repairs at an authorized service centre.**



The unit is designed for operation in an industrial environment and must not be used in a household environment or similar.

2. GENERAL CHARACTERISTICS

Module type **SOC-8** is designed for low power devices controlling via RS-485 interface. **SOC-8** can be applied to distributed controlling, visualisation and signalling systems. The module can drives relays, bulbs, LEDs and other DC current devices with power voltage not higher than 24V and current up to 0.5A. Full galvanic isolation allows safe operation of HOST system without any risk of its faults caused by high voltage. All operating functions of **SOC-8** are available by RS-485 interface, and can be controlled by any visualisation software (using MODBUS RTU protocol). Standard functions of Modbus protocol allows to change device address and detects its type.

3. TECHNICAL DATA

Power supply voltage	16... 24 ...30V DC (separated)
External fuse (required)	T - type, max. 1 A
Current consumption	20mA typically
Number of independent outputs	8
Signalisation of output state	LED light when output is active

Max output current	0.5A / single output, max. 2 active outputs 0.2A / single output, all outputs active
Galvanic isolation	All outputs are galvanically isolated from module supply and RS-485 interface
Communication interface	RS 485, 8N1 / Modbus RTU
Baud rate	1200 ÷ 115200 bit/s
Number of modules in 1 network	maximum 128
Data memory	non-volatile memory, EEPROM type
Protection level	IP 20 (housing and connection clips)
Housing type	DIN rail mounted (35 mm rail)
Housing dimensions (L x W x D)	101 x 22.5 x 80 mm
Operating temperature (depending on version)	0°C to +50°C or -20°C to +50°C
Storage temperature (depending on version)	-10°C to +70°C or -20°C to +70°C
Humidity	5 to 90% no condensation
Altitude	up to 2000 meters above sea level
Screws tightening max. torque	0.5 Nm
Max. connection leads diameter	2.5 mm ²
EMC	according to: PN-EN 61326-1



This is a class A unit. In housing or a similar area it can cause radio frequency interference. In such cases the user can be requested to use appropriate preventive measures.

4. DEVICE INSTALLATION

The unit has been designed and manufactured in a way assuring a high level of user safety and resistance to interference occurring in a typical industrial environment. In order to take full advantage of these characteristics installation of the unit must be conducted correctly and according to the local regulations.



- Read the basic safety requirements on page 3 prior to starting the installation.
- Ensure that the power supply network voltage corresponds to the nominal voltage stated on the unit's identification label.
- The load must correspond to the requirements listed in the technical data.
- All installation works must be conducted with a disconnected power supply.

4.1. UNPACKING

After removing the unit from the protective packaging, check for transportation damage. Any transportation damage must be immediately reported to the carrier. Also, write down the unit serial number on the housing and report the damage to the manufacturer.

Attached with the unit please find:

- user's manual,
- warranty,

4.2. CONNECTION METHOD

Caution



- Installation should be conducted by qualified personnel . During installation all available safety requirements should be considered. The fitter is responsible for executing the installation according to this manual, local safety and EMC regulations.
- Wiring must meet appropriate standards and local regulations and laws.
- In order to secure against accidental short circuit the connection cables must be terminated with appropriate insulated cable tips.
- Tighten the clamping screws. The recommended tightening torque is 0.5 Nm. Loose screws can cause fire or defective operation. Over tightening can lead to damaging the connections inside the units and breaking the thread.
- In the case of the unit being fitted with separable clamps they should be inserted into appropriate connectors in the unit, even if they are not used for any connections.
- **Unused clamps (marked as n.c.) must not be used for connecting any connecting cables (e.g. as bridges), because this can cause damage to the equipment or electric shock.**

Due to possible significant interference in industrial installations appropriate measures assuring correct operation of the unit must be applied. To avoid the unit of improper indications keep recommendations listed below.

- Avoid common (parallel) leading of signal cables and transmission cables together with power supply cables and cables controlling induction loads (e.g. contactors). Such cables should cross at a right angle.
- Contactor coils and induction loads should be equipped with anti-interference protection systems, e.g. RC-type.
- Use of screened signal cables is recommended. Signal cable screens should be connected to the earthing only at one of the ends of the screened cable.
- In the case of magnetically induced interference the use of twisted couples of signal cables (so-called "spirals") is recommended. The spiral (best if shielded) must be used with RS-485 serial transmission connections.

- In the case of interference from the power supply side the use of appropriate anti-interference filters is recommended. Bear in mind that the connection between the filter and the unit should be as short as possible and the metal housing of the filter must be connected to the earthing with largest possible surface. The cables connected to the filter output must not run in parallel with cables with interference (e.g. circuits controlling relays or contactors).

External powers supply must be connected to the module (+Uz, -Uz, typically 24V DC) and two wires RS-485 (A+, B-) communication interface. Outputs are placed on bottom side of the module (see: Figure 4.1).

Common signal of the outputs (GND and Vpp) must be connected to the module, these signals are required for proper operation of the module. It is recommended to separate output signals (power and GND) from power supply of the module (e.g. use other power supplies). Controlling of the device is realized by internal connection of particular output to GND.

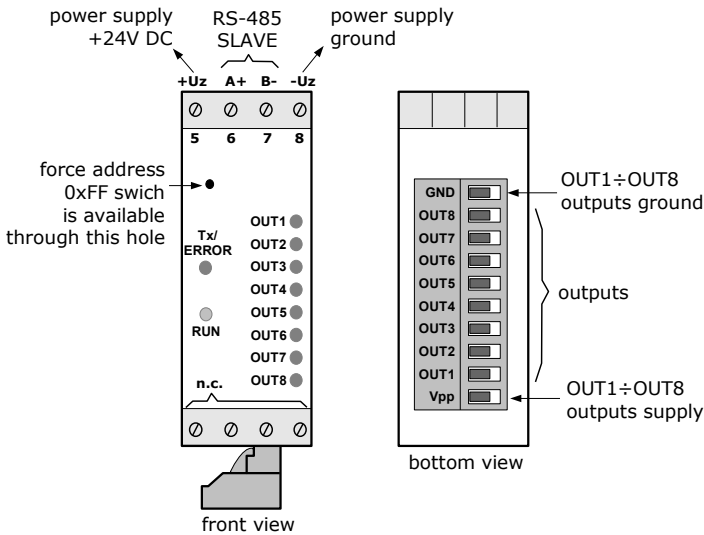

Figure 4.1. Terminals description



- When use of SMPS it is strongly recommended to connect PE wire.
- All connections must be made while power supply is disconnected !

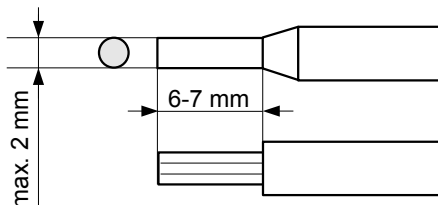

Figure 4.2. Method of cable insulation replacing and cable terminals

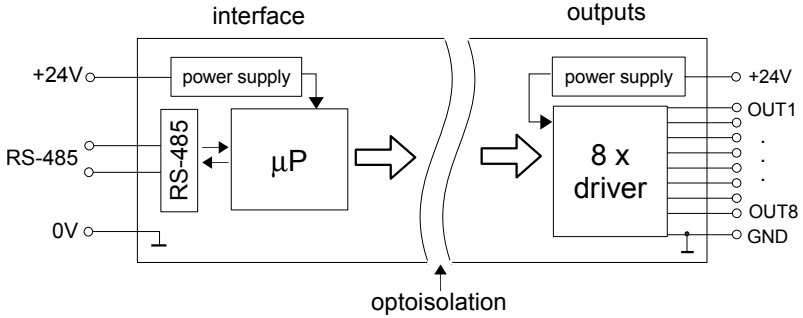

Figure 4.3. Block schematic of SOC-8

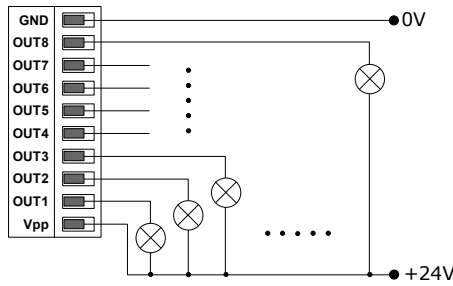

Figure 4.4. Recommended method of resistive load connection

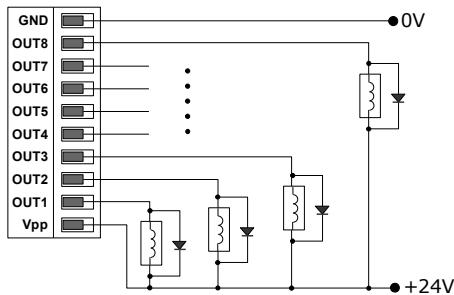

Figure 4.5. Recommended method of inductive load connection

4.3. MAINTENANCE

The unit does not have any internal replaceable or adjustable components available to the user. Pay attention to the ambient temperature in the room where the unit is operating. Excessively high temperatures cause faster ageing of the internal components and shorten the fault-free time of unit operation.

In cases where the unit gets dirty do not clean with solvents. For cleaning use warm water with small amount of detergent or in the case of more significant contamination ethyl or isopropyl alcohol.



Using any other agents can cause permanent damage to the housing.



Product marked with this symbol should not be placed in municipal waste. Please check local regulations for disposal and electronic products.

5. PRINCIPLE OF OPERATION

Directly after power on the device is signalling its normal operation flashing green LED marked „RUN” (about 2 times/sec.). Short flashes of LED marked Tx/ERROR signalize activity of RS-485 interface, and permanent light of this LED signalizes malfunction of the device.

Using transmission over RS-485 interface it is possible to change the state of device outputs (see: ***THE MODBUS PROTOCOL HANDLING***). Red LEDs marked OUT1 ÷ OUT8 signalize active state of outputs. Pay special attention for permissible currents of outputs, and the sum of all currents (see ***TECHNICAL DATA***).

The device has three registers (address: 0Bh, 0Ch, 0Dh) used for controlling the state of the outputs while lost of communication with HOST device. The content of 0Dh register decides about the state of the outputs after communication lost. Its lower byte is a PRE-alarm state, activated after time delay defined by register 0Bh (in seconds, range 0 to 65535 seconds), since lost of communication. The higher byte of reg. 0Dh defines final state of outputs, and is activated after delay stored in register 0Ch since PRE-alarm activation. Register 0Ch is expressed in seconds too, and has range from 0 to 65535. Setting of PRE-alarm or FINAL state delay to 0 causes in turning off this option. After power on device sets all outputs according to its FINAL state (higher byte of reg. 0Dh content). Internal time counters are cleared after every write to the device via RS-485 interface.

Forcing of 0xFF address

New devices has set to Modbus addresses 0xFE. To enhance system installation process special operation mode has been developed. It allows to force address 0xFF in single module using internal momentary switch mounted on module mainboard (Figure 4.1).

To change address of the device to FFh, wait for a moment after power up until green LED (RUN) starts flashes. Next press and hold push-button about 4 seconds until green LED will lights permanently, then release push-button.

The device changes its MODBUS address to FFh and waits for a new address (readdressing). Green LED (RUN) stay permanently on until readdressing via RS-485, or power off. While module is in this state it is possible to control its inputs, and communication is possible using temporal address FFh.

At this moment MASTER controller should find new device and readdress it (to address other than 0xFF and 0xFE). After remote readdressing green LED indicator starts to flashes again.

Simultaneously with change of device address, baud rate is changed to 9600 bit/s.

Required transmission speed (1200 bit/s. to 115200 bit/s.) can be set by write to register 22h. After change of transmission speed the device sends the answer with new baud rate. While installation of the new network it is recommended to readdress all devices using baud rate 9600 bit/s, and next change speed of all devices simultaneously, using BROADCAST query (with address 00h).

5.1. EXAMPLES OF OUTPUT CONTROLLING

1. No control of communication lost

Content of registers : 0Bh = 0; 0Ch = 0; 0Dh = FF00h;

Operation: Device do not controls delays between successive writings. After power on outputs are set to state FFh.

2. Control without PRE-alarm

Content of registers : 0Bh = 0; 0Ch = 60; 0Dh = FF00h;

Operation: After 60 seconds since last write to any of output registers the device goes to FINAL state, and sets its outputs to FFh. The device stays in this state to the next write to any of output registers. After power on outputs are set to state FFh.

3. Control with PRE-alarm

Content of registers : 0Bh = 120; 0Ch = 60; 0Dh = FF00h;

Operation: After 120 seconds since last write to any of output registers the device goes to PRE-alarm state, and sets its outputs to 00h. After next 60 seconds since last write to any of output registers the device goes to FINAL state, and sets its outputs to FFh.. The device stays in this state to the next write to any of output registers. After power on outputs are set to state FFh.

4. Control with PRE-alarm, without FINAL-state

Content of registers : 0Bh = 120; 0Ch = 0; 0Dh = FF00h;

Operation: After 120 seconds since last write to any of output registers the device goes to PRE-alarm state, and sets its outputs to 00h. The device stays in this state to the next write to any of output registers or to power supply off. After power on outputs are set to state FFh.

6. THE MODBUS PROTOCOL HANDLING

Transmission parameters: 1 start bit, 8 data bits, 1 stop bit, no parity control
 Baud rate: selectable from: 1200 to 115200 bits/second
 Transmission protocol: MODBUS RTU compatible

The device parameters and display value are available via RS-485 interface, as HOLDING-type registers (numeric values are given in U2 code) of Modbus RTU protocol. The registers (or groups of the registers) can be read by 03h function, and wrote by 06h (single registers) accordingly to Modbus RTU specification. Maximum group size for 03h function can not exceeds 12 registers (for single frame).



The device interprets the broadcast messages, but then do not sends the answers.

6.1. LIST OF REGISTERS

Register	Write	Range	Register description
01h - 08h	Yes	0 or 1	The state of particular outputs (numbers of outputs are the same as register numbers) (1 – closed=on , 0 - open=off)
09h	Yes	0 ÷ 00FFh	The state of all outputs (bits are ascribed to outputs) Bit 0 corresponds to OUT1, bit 1 – to OUT2 and so on
0Bh	Yes	0 ÷ FFFFh	PRE-alarm delay, expressed in seconds, 0 – PRE-alarm is off
0Ch	Yes	0 ÷ FFFFh	FINAL state delay, expressed in seconds, 0 – FINAL state is off (is set only after power on)
0Dh	Yes	0 ÷ FFFFh	Higher byte – FINAL state lower byte – PRE-alarm state
20h ¹	Yes	1 ÷ FFh	Device address. New devices has default address = FEh
21h	No	0099h	Device identification code (ID)
22h ²	Yes	0 ÷ 7	Baud rate [bit/sec]: 0 - 1200; 1 - 2400; 2 - 4800; 3 - 9600; 4 - 19200; 5 - 38400; 6 - 57600; 7 - 115200
FFF3h	No	0000 ÷ FFFFh	Firmware version (hexadecimal): e.g.: value 0123h means version 1.23

1 - after writing to register no 20h the device responds with an "old" address in the message.

2 - after writing to register no 22h the device responds with the new baud rate.



If register 20h is being written it is possible to use BROADCAST frame (with address 00). This operation causes changing of addresses of all modules connected to the RS-485 network. Modules receive and interprets BROADCAST frames, but do not transmit answers.

6.2. TRANSMISSION ERRORS DESCRIPTION

If an error occurs while write or read of single register, then the device sends an error code according to Modbus RTU specifications.

Error codes:

01h - illegal function (only functions 03h and 06h are available),

02h - illegal register address

03h - illegal data value

6.3. EXAMPLES OF QUERY/ANSWER FRAMES

Examples apply for device with address 1. All values are represent hexadecimal.

Field description:

ADDR Device address on modbus network

FUNC Function code

REG H,L Starting address (address of first register to read/write, Hi and Lo byte)

COUNT H,L No. of registers to read/write (Hi and Lo byte)

BYTE C Data byte count in answer frame

DATA H,L Data byte (Hi and Lo byte)

CRC L,H CRC error check (Hi and Lo byte)

1. Read of device ID code

ADDR	FUNC	REG H,L		COUNT H,L		CRC L,H	
01	03	00	21	00	01	D4	00

The answer:

ADDR	FUNC	BYTE C	DATA H,L		CRC L,H	
01	03	02	00	99	78	2E

DATA - identification code (0099h)

2. Change of the device address from 1 to 2 (write to reg. 20h)

ADDR	FUNC	REG H,L		DATA H,L		CRC L,H	
01	06	00	20	00	02	09	C1

DATA H - 0

DATA L - new device address (2)

The answer (the same as the message):

ADDR	FUNC	REG H,L		DATA H,L		CRC L,H	
01	06	00	20	00	02	09	C1

3. Setting of OUT1 state

ADDR	FUNC	REG H,L		DATA H,L		CRC L,H	
01	06	00	01	00	01	19	CA

The answer (the same as the message):

ADDR	FUNC	REG H,L		DATA H,L		CRC L,H	
01	06	00	01	00	01	19	CA

4. Simultaneous change of all outputs state

ADDR	FUNC	REG H,L		COUNT H,L		CRC L,H	
01	03	00	09	00	01	54	08

The answer:

ADDR	FUNC	BYTE C	DATA H,L		CRC L,H	
01	03	02	00	01	79	84

DATA L= 01 – OUT 1 is active, all other inactive



There is no full implementation of the Modbus Protocol in the device. The functions presented above are available only.

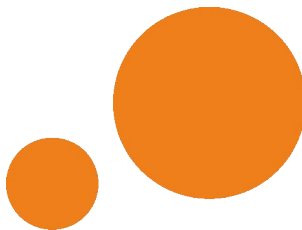

**SIMEX Sp. z o.o.
ul. Wielopole 11
80-556 Gdańsk
Poland**

**tel.: (+48 58) 762-07-77
fax: (+48 58) 762-07-70**

**<http://www.simex.pl>
e-mail: info@simex.pl**