

TEMPERATURE CONTROLLER

33 X 72
KR1 model

Quick Guide • ISTR-FKR1ENGO6



viale Indipendenza 56, 27029 - Vigevano (PV) - ITALIA
Tel.: +39 0381 698 71, Fax: +39 0381 698 730
Sito internet: www.ascontecnologic.com
E-mail: sales@ascontecnologic.com

DECLARATION OF CONFORMITY AND MANUAL RETRIEVAL

KR1 is a panel mounting, Class II instrument. It has been designed with compliance to the European Directives. All information about the controller use can be found in the Engineering Manual: ISTR-MKR_ENGOx ("x" is the revision). The Declaration of Conformity and the manual of the controller can be downloaded (free of charge) from the web-site:

www.ascontecnologic.com

Once connected to the web-site, search: KR1 then click on KR1.

In the lower part of the product page (in any language) is present the download area with links to the documents available for the controller (in the available languages).

Warning!

- Whenever a failure or a malfunction of the device may cause dangerous situations for persons, things or animals, please remember that the plant must be equipped with additional devices which will guarantee safety.
- We warrant that the products will be free from defects in material and workmanship for 18 months from the date of delivery. Products and components that are subject to wear due to conditions of use, service life and misuse are not covered by this warranty.

Disposal

The appliance (or the product) must be disposed of separately in compliance with the local standards in force on waste disposal.

DISPLAY AND KEYS

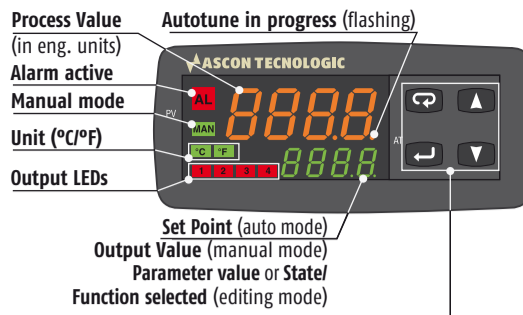

Operator Mode	Editing Mode
<ul style="list-style-type: none"> Access to: <ul style="list-style-type: none"> - Operator Commands - Parameters - Configuration 	Confirm and go to Next parameter
<ul style="list-style-type: none"> Access to: <ul style="list-style-type: none"> - Operator additional information - Set Point 	Increase the displayed value/Selects the parameters list next element
<ul style="list-style-type: none"> Access to: <ul style="list-style-type: none"> - Set Point 	Decrease the displayed value or select the previous element
<ul style="list-style-type: none"> Programmable key: <ul style="list-style-type: none"> - Start the programmed function (Autotune, Auto/Man, Timer ...) 	Exit from Operator commands/Parameter setting/Configuration

+ These 2 keys, pressed in sequence, allow to toggle between MANUAL and AUTO modes.

DIMENSIONS

Overall dimensions (L x H x D): 78 x 35 x 69.5 mm
(3.07 x 1.37 x 2.73 in.)
Panel Cut-out (L x H): 71+0.6 x 29+0.6 mm
(2.79+0.023 x 1.14+0.023 in.)

MOUNTING

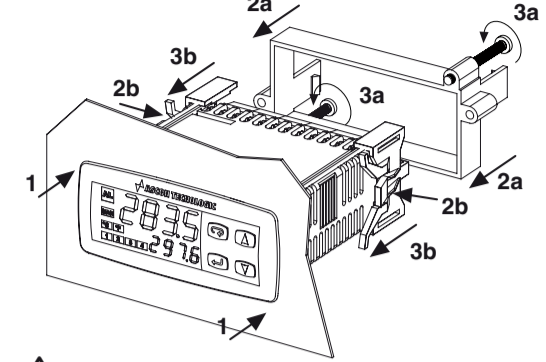

Attention

The controller can be installed using 2 different types of brackets. Follow the sequence 1, 2a, 3a for the screw bracket (collar bracket for IP65), the sequence 1, 2b, 3b for the "butterfly" brackets (2 pieces).

MODEL CODE

The Hardware resources are identified by the following Model Code.

Model: KR 1 A B C D E F G H I - 0 0 0 0

Line	KR	1
Optional functions	A	-
None	-	-
Timer	T	-
Power Supply	B	-
100... 240Vac (-15... +10%)	H	-
24Vac (-25... +12%) or 24Vdc (-15... +25%)	L	-
Input	C	-
TC, PT100, PT1000, mA, mV, V + Digital Input 1	C	-
TC, NTC, PTC, mA, mV, V + Digital Input 1	E	-
Output OP1	D	-
Relay (1 SPDT, 4 A/250 Vac)	R	-
VDC for SSR (12 Vdc/20 mA)	O	-
Output OP2	E	-
None	-	-
Relay (1 SPST NO, 4 A/250 Vac)	R	-
VDC for SSR VDC for SSR (12 Vdc/20 mA)	O	-

Output OP3	F
None	-
Relay (1 SPST NO, 4 A/250 Vac)	R
Vdc for SSR VDC for SSR (12 Vdc/20 mA)	O
Output OP4	G
Digital I/O (see the Electrical Connections paragraph for details)	D
Serial Communications	H
TTL	-
RS485 Modbus	S
Terminal Type	I
Standard (screw type non removable terminal blocks)	-
With plug-in screw type terminal blocks	E
With plug-in clamp type terminal blocks	M
With plug-in terminal blocks (fixed part only)	N

Model Code example: KR1-HCRRRD--

Controller KR1, no timer, 100... 240 Vac, TC/PT100/PT1000/mV/V + Digital Input 1, 3 Relay Outputs, Output 4, TTL, non removable screw type terminals.

ELECTRICAL CONNECTIONS

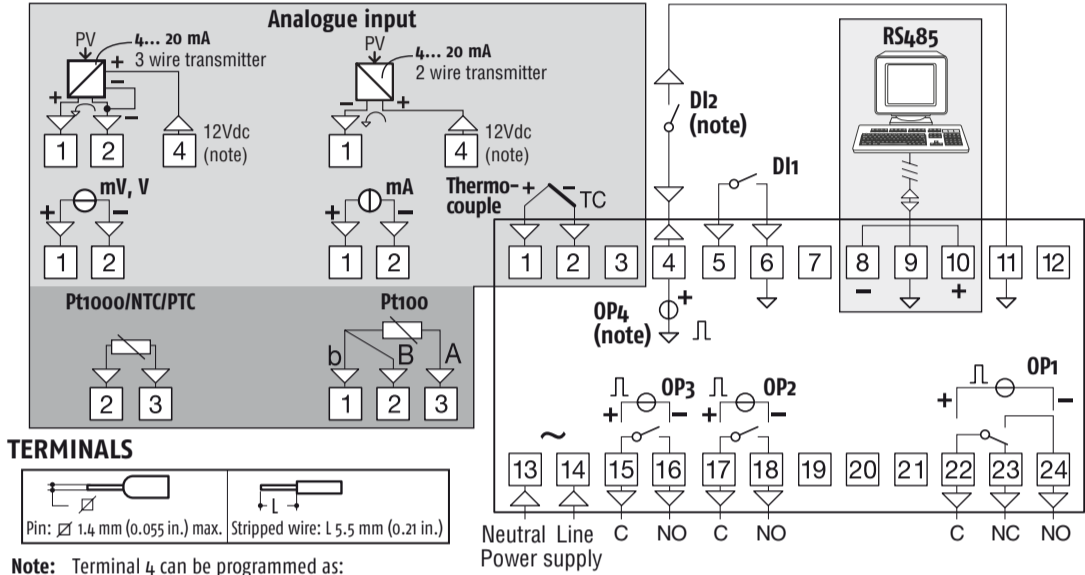

TERMINALS

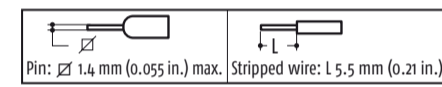

Note: Terminal 4 can be programmed as:

- Digital Input (DI2) connecting a free of voltage contact between terminals 4 and 11;
- 0... 12 V SSR Drive Output (OP4) connecting the load between terminals 4 and 11;
- 12 Vdc (20 mA) transmitter power supply connecting the 2 wire transmitter between terminals 4 and 1; for 3 wire transmitter connect terminal 4 to transmitter power supply input and terminal 1 and 2 to transmitter signal output.

Supply voltage: 100... 240 Vac/
18... 28 Vac/
20... 30 Vdc

CONFIGURATION CODE

The KR1 can be easily configured by the "Code Configuration" method for the most common requirements, just entering two 4-digit codes: Cod 1 [LMNO] for the Input Type and Control Mode selection and Cod 2 [PQRS] for the Alarms and the Service Functions. For complete controller configuration see the Engineering Manual.

Note: Before starting the configuration code setting, please define and write down Cod 1 and Cod 2 as needed:

HOW TO SET THE CONFIGURATION CODE



Press **Enter** for 3 seconds to access the configuration mode



Press **Up** and **Down** to enter the configuration Password 4 (default 300)



Press **Up** and **Down** to enter Cod 1 (Input Type and Control Mode)



Press **Up** and **Down** to enter Cod 2 (Alarms and Service Functions)



Press **Enter** to store the Configuration code

Note: To leave the Configuration session without saving the settings made, press the **Enter** key



Input Type and Range	L	M
TC J	-50... +1000°C	0 0
TC K	-50... +1370°C	0 1
TC S	-50... +1760°C	0 2
TC R	-50... +1760°C	0 3
TC T	-70... +400°C	0 4
Infrared J	-50... +785°C	0 5
Infrared K	-50... +785°C	0 6
PT 100/PTC KTY81-121	-200... +850°C/-55... +150°C	0 7
PT 1000/NTC 103-AT2	-200... +850°C/-50... +110°C	0 8
Linear 0... 60 mV		0 9
Linear 12... 60 mV		1 0
Linear 0... 20 mA (this selection forces Out 4 = TX)		1 1
Linear 4... 20 mA (this selection forces Out 4 = TX)		1 2
Linear 0... 5 V		1 3
Linear 1... 5 V		1 4
Linear 0... 10 V		1 5
Linear 2... 10 V		1 6
TC J	-58... +1832°F	1 7
TC K	-58... +2498°F	1 8
TC S	-58... +3200°F	1 9
TC R	-58... +3200°F	2 0
TC T	-94... +752°F	2 1
Infrared J	-58... +1445°F	2 2
Infrared K	-58... +1445°F	2 3
PT 100/PTC KTY81-121	-328... +1562°F/-67... +302°F	2 4
PT 1000/NTC 103-AT2	-328... +1562°F/-58... +230°F	2 5



Alarm 3	Q	R
Alarm 2		
Alarm 1	P	
Not used	0	0
Sensor break	1	1
Absolute		
High	2	2
Low	3	3
Absolute High/Low		
External High/Low	4	4
Internal High/Low	5	5
Deviation high	6	6
Deviation low	7	7
Band		
External band	8	8
Internal band	9	9

Control mode	OP1	OP2	OP3	OP4	N	O
ON/OFF heating = H	H	AL1	AL2	AL3	0	0
ON/OFF cooling = C	C	AL1	AL2	AL3	0	2
ON/OFF with neutral zone (H/C)	H	C	AL2	AL3	0	4
PID heating = H	H	AL1	AL2	AL3	1	0
PID cooling = C	C	AL1	AL2	AL3	1	2
PID double action (H/C)	H	C	AL2	AL3	1	4
	H	AL1	AL2	C	1	5
	C	H	AL2	AL3	1	6
	C	AL1	AL2	H	1	8
	NU	C	AL2	H	1	9

Note: As default, when the alarms are active, only AL1 threshold is available at "Operator Command" level to perform non critical tasks. To protect the AL2 and AL3 thresholds against undesired changes, they are available only at "Parameters list" level (password: 20). For different configurations, see the Engineering Manual.

Service functions activation	S
None	0
Wattmeter (instantaneous power expressed in kW) (note 1)	1
Wattmeter (Power consumption expressed in kWh/h) (note 2)	2
Absolute worked time (expressed in days) (note 3)	3
Absolute worked time (expressed in hours) (note 3)	4

1. **Wattmeter Instantaneous power** is continuously computed as multiplication of the Load Voltage, Load Current parameter values and the controller output instantaneous value.
2. **Wattmeter power consumption** is the estimated hourly energy consumption (using Load Voltage and Load Current parameter values), computed on the previous 15 minutes period. The readout is updated every 15 minutes.
3. **Worked Time counter** is continuously increased when the controller is turned ON.

ALARM TYPES (Cod 2 digits: P, Q, R)

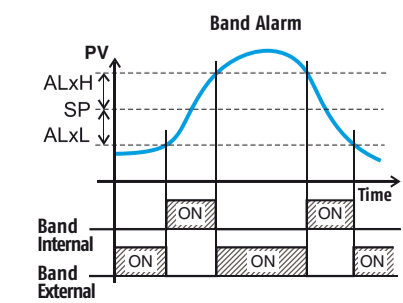
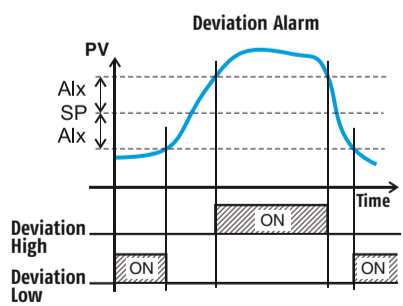
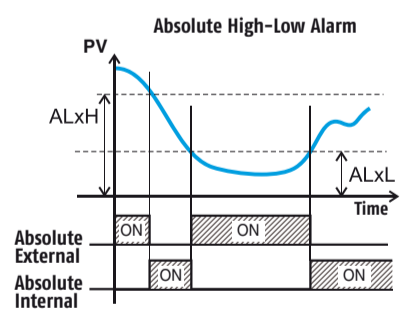
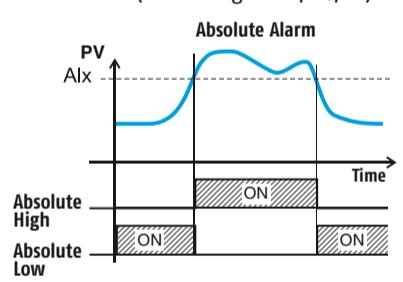

PARAMETERS SETTING

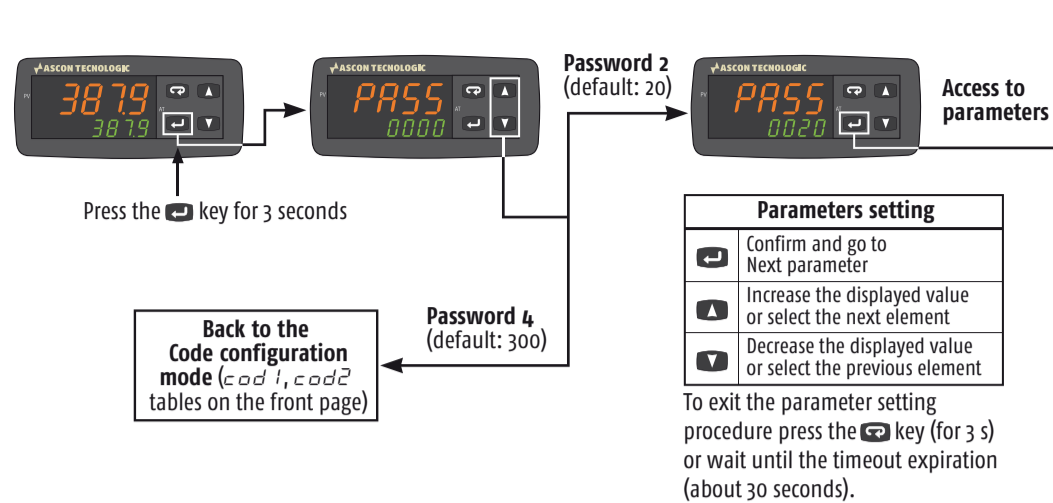

CONTROLLER OPERATION

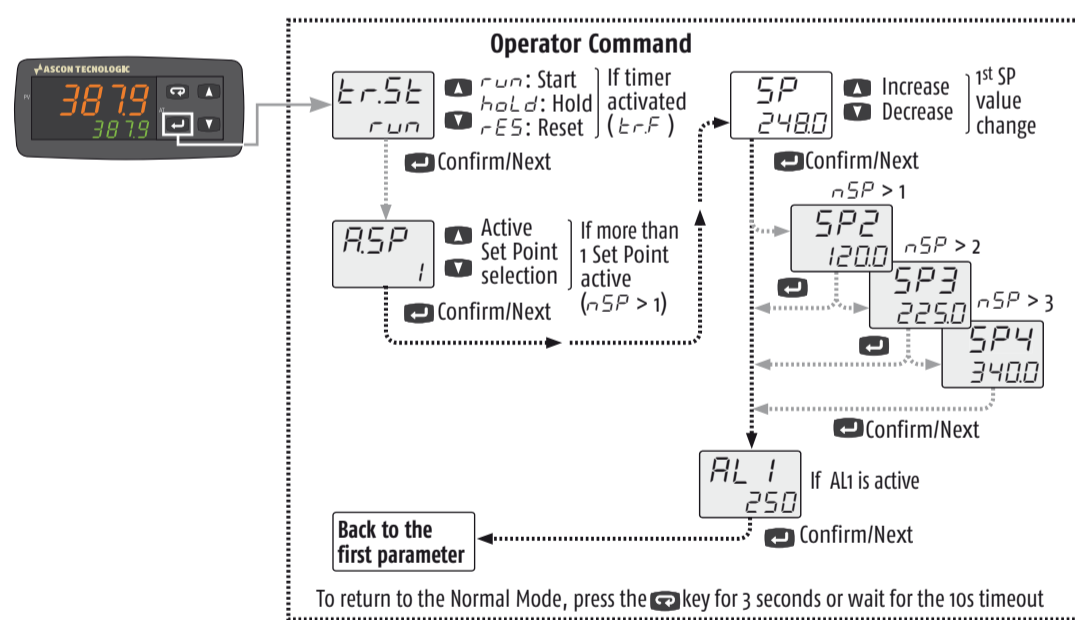
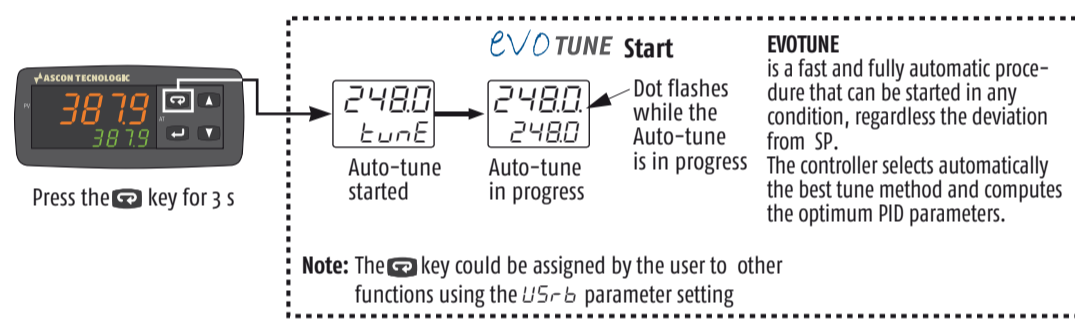
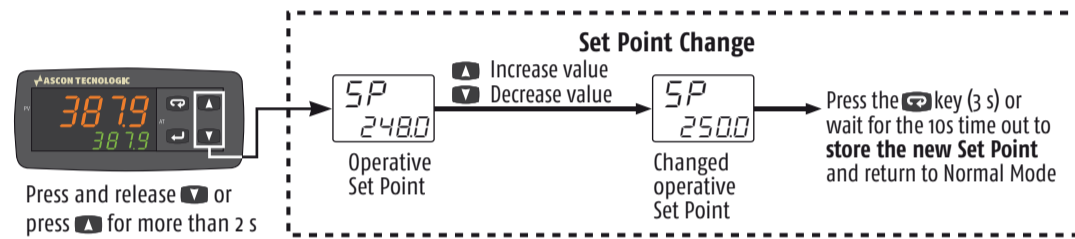
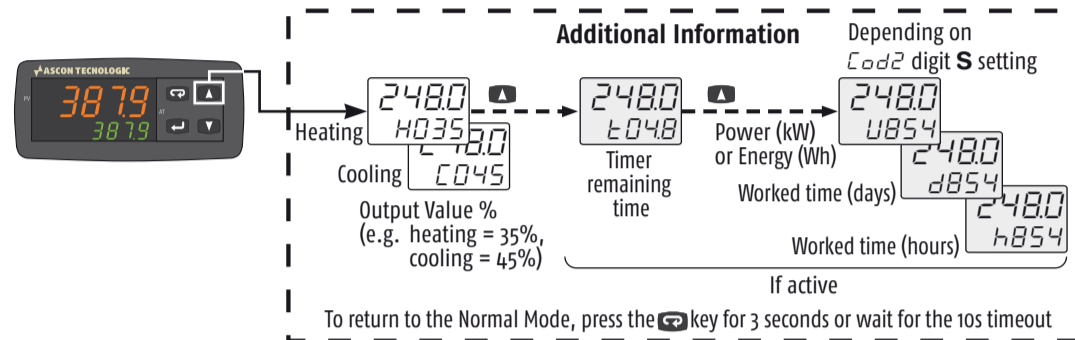

FUNCTION SELECTION

Timer Types (selected by trF) (option)

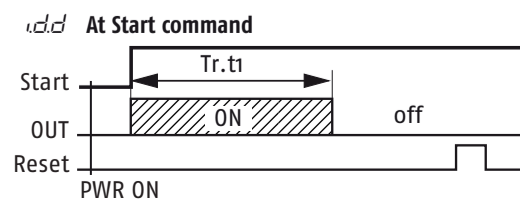
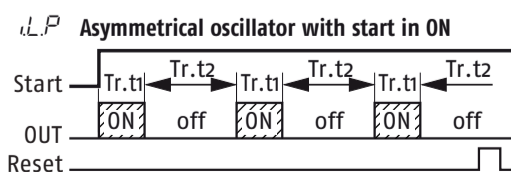
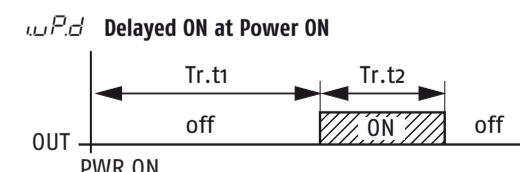
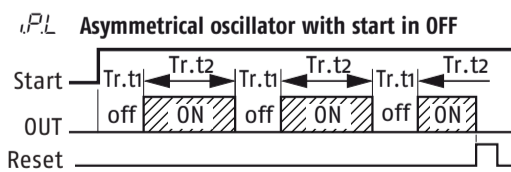
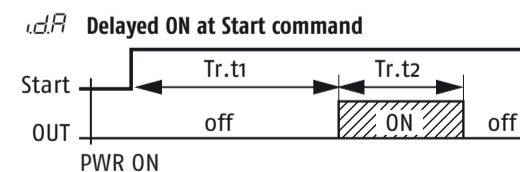

Parameters List (PASS: 20) (in gray the parameters related to optional features)

Group	Param.	Description	Range value or selection list elements	Default	User value	Note
Commands	trSt	Timer status				Option
	oPEr	Operative Mode Selection	reg Auto, oplo Manual, stdy Standby			
	ASP	Set Point Selection	0 = SP, 1 = SP2, 2 = SP3, 3 = SP4	0		
	tunE	Start Auto Tune	0 = off, 1 = start	0		evoTUNE
Control	Pb	Proportional Band	1... 9999 (Engineering Units = E.U.)	20		
	tI	Integral Time	0... 10000 s	200		Cod1 Digit N = 1
	tD	Derivative Time	0... 1000 s	50		
	HSEt	Hysteresis ON/OFF Control	0... 9999 (E.U.)	1		Cod1 Digit N = 0
	tCH	Heating output cycle time	0.2... 130 s	20.0		Cod1 Digit N = 1
	rCG	Relative Cooling Gain	0.01... 99.99	1.00		Cod1 Digit N = 1 Cod1 Digit O > 4
	tCC	Cooling output cycle time	0.2... 130 s	20.0		Cod1 Digit N = 1 Cod1 Digit O > 1
	Set Point	SP	Set Point 1	-1999... +9999 (E.U.)		
SP2		Set Point 2				If nSP > 1
SP3		Set Point 3	-1999... +9999 (E.U.)			If nSP > 2
SP4		Set Point 4				If nSP > 3
SPLL		Set Point min. Value	-1999... SPHL (E.U.)			
SPHL		Set Point max. Value	SPLL... 9999 (E.U.)			
Alarms	nSP	No. of Set Points	1... 4	1		
	AL1	Alarm 1 threshold	AL1L... AL1H			
	AL1L	Alarm 1 low threshold/Low limit	-1999... +9999 (E.U.)	-1999		If digit P of Cod2 is > 1
	AL1H	Alarm 1 high threshold/High limit		9999		
	HAL1	AL1 hysteresis	1... 9999 (E.U.)	1		
	AL2	Alarm 2 threshold	AL2L... AL2H			
	AL2L	Alarm 2 low threshold/Low limit	-1999... +9999 (E.U.)	-1999		If digit Q of Cod2 is > 1
	AL2H	Alarm 2 high threshold/High limit		9999		
	HAL2	AL2 hysteresis	1... 9999 (E.U.)	1		
Soft Start	SSP	Soft Start Output value	-100... 100%	0		
	SSt	Soft Start Time	0.00... 8.00 (hh.mm)	0		
	SSc	Low Scale readout	-1999... 9999	-1999		For linear Input types only
Input	FSH	High Scale readout	-1999... 9999	9999		
	dP	Number of decimals	0... 3 (linear inputs), 0... 1 (other inputs)	0		
	FIL	Measured value Digital filter	0 OFF, 0.1... 20.0 s	0		
Timer	trF	Timer Type	nonE Timer not used, i.d.A Delayed ON at start command, i.u.P.d Activation ON at Power ON, i.d.d At start command, i.P.L Asymmetrical oscillator, start in OFF, i.L.P Asymmetrical oscillator, start in ON	none		Timer management (Start, Stop, Reset) can be done using the trSt command or the key (if programmed) or by the Dh1/Dh2 digital inputs (if programmed).
	trU	Timer Units	0 hh.mm, 1 mm.ss, 2 sss.d	1		
	trt1	Time 1	00.01... 995.9	1.00		
I/O	trt2	Time 2	00.00... 995.9	1.00		
	io4F	I/O 4 Function	ON Transmitter Power Supply, OUT4 SSR out, Di2C Digital Input from contact, Di2U 24 VDC Digital Input	ON		
	Digital Inputs	diF1	Digital Input 1 Function	0... 21	0	
diF2		Digital Input 2 Function	0... 21	0		
uSrb		Key Function	nonE, tunE, oplo, aac, asi, chsp, st.by, str.t, HE.co	tunE		See the Key function table
Display	diCL	Colour of the Process Value display	0 Change, 1 Red, 2 Green, 3 Orange	2		If Change, the colour is green if PV differs from SP less than AdE, red if higher than AdE and orange if is lower than AdE
	AdE	Display change color threshold (when diCL = 0)	0 OFF 1... 9999 (E.U.)			
	diSt	Display Power OFF time	0 Display ON 0.1... 99.59 (mm.ss)	OFF		
Serial communications	Addr	Instrument Address	1... 254	1		Modbus RTU slave protocol
	brud	Baud rate	1200, 2400, 9600 baud, 19.2, 38.4 kbaud	9600		
Wattmeter	UoLk	Load Voltage	1... 999 (V)	230		If digit S of Cod2 is > 1
	cur	Load Current	1... 9999 (A)			
Password	PAS4	Configuration access Password	0... 999	300		
	PAS2	Parameters access Password	0... 999	20		

Note: To access all the instrument features, please see the "Complete configuration procedure" in the "Engineering Manual".

Complete Configuration and Parameter setting can be easily uploaded from the controller and downloaded to other controllers using the Configuration Key and Communication Adapter model: A-01.

diF1 Digital Inputs Dh1 and Dh2 Functions

uSrb Key Function

Code displayed	Description
0	Disabled (OFF) (default)
1	Alarm Reset
2	Alarm Acknowledge (ACK)
3	Hold of the measured value
4	Stand by mode
5	Manual Mode
6	Heat with "SP" and Cool with "SP2"
7	Timer Run/Hold/Reset [on transition]
8	Timer Run [on transition]
9	Timer Reset [on transition]
10	Timer Run/Hold
11	Timer Run/Reset
12	Timer Run/Reset with lock at the end of the time count
18	Sequential Set Point selection [on transition]
19	SP/SP2 selection
20	Binary coding for Set Point selection on Dh1 and Dh2 (00 = SP, 01 = SP2, 10 = SP3, 11 = SP4)
21	Digital inputs in parallel to and keys (Dh1 = , Dh2 =)

Code displayed	Description
nonE	Not used
tunE	Starts auto tuning functions (default)
oPLo	Manual mode
ARc	Alarm Reset
ASv	Alarm Acknowledge
chSP	Circular Set Point Selection (shows SP, SP2, SP3)
Stby	Stand-by mode
StRt	Starts/Stop/Reset timer
HEco	Heat with "SP"/Cool with "SP2"