

EN580E.ML-TT14.GA11G.13120.H

Through hollow shaft, optical multiturn encoders 13 bit ST / 12 bit MT, SSI

Article number: 11246062

Overview

- Absolute encoder multiturn
- Optical sensing method
- Resolution: singleturn 13 bit, multiturn 12 bit
- Maximum resistant against magnetic fields
- High connection flexibility thanks to flexible connector M12



Technical data

Technical data - electrical ratings

Voltage supply	8...30 VDC
Reverse polarity protection	Yes
Short-circuit proof	Yes
Consumption w/o load	≤80 mA (24 VDC)
Interface	SSI
Function	Multiturn
Steps per revolution	8192 / 13 bit
Number of revolutions	4096 / 12 bit
Absolute accuracy	±0.03 °
Sensing method	Optical
Code	Gray
Code sequence	CW: ascending values with clockwise sense of rotation; looking at flange
Input signals	SSI clock Zero setting input Counting direction
Output stages	SSI data: Linedriver RS422
Output signals	SSI data
Interference immunity	EN 61000-6-2

Technical data - electrical ratings

Emitted interference	EN 61000-6-4
Approval	UL Class 2
Technical data - mechanical design	
Size (flange)	ø58 mm
Shaft type	ø14 mm (through hollow shaft)
Protection EN 60529	IP 54 (flange side) IP 65 (housing side)
Operating speed	≤6000 rpm (+25 °C)
Starting torque	≤0.04 Nm
Motor shaft tolerance	± 0.2 mm (axial offset) ≤ 0.1 mm (radial offset) ≤ 0.1 mm (concentricity)
Material	Housing: aluminium Shaft: stainless steel
Operating temperature	-25...+85 °C (see general information)
Relative humidity	95 % non-condensing
Resistance	EN 60068-2-6 Vibration 10 g, 10-2000 Hz EN 60068-2-27 Shock 100 g, 11 ms
Weight approx.	400 g
Connection	Connector M12, 8-pin, flexible

General information

Self-heating correlated to installation and ambient conditions as well as to electronics and supply voltage must be considered for precise thermal dimensioning. Operating the encoder close to the maximum limits requires measuring the real prevailing temperature at the encoder flange.

Terminal assignment

Connector M12, 8-pin

Pin	Assignment
1	0 V
2	+Vs
3	Clock+
4	Clock-
5	Data+
6	Data-
7	SET
8	DIR



Data transfer

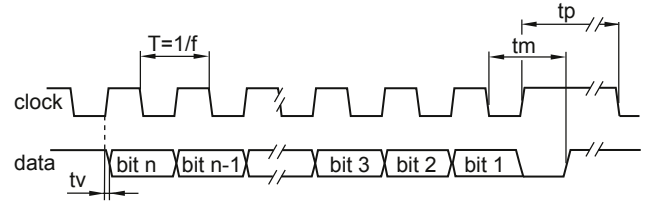

Clock frequency f	80...2000 kHz
Delay time tv	70 ns (RL = 120 Ohm)
Monoflop time tm	16 ... 24 µs + T/2
Clock interval tp	30 µs

Terminal significance

SET	Zero setting input. Input for zero setting at any position. The zero setting operation is triggered by a high pulse and has to be in line with the selected direction of rotation (DIR). Impulse duration >100 ms. Connect to 0 V after zero setting for maximum interference immunity.
DIR	Counting direction input. This input is standard on high. DIR-High means ascending output data with clockwise shaft rotation when looking at flange. DIR-Low means ascending values with counterclockwise shaft rotation when looking at flange. For maximum interference immunity connect to +Vs respectively 0 V depending on counting direction.

Trigger level

SSI	Circuit
SSI-Clock	RS422 with terminating resistor 120 Ω
SSI-Data	RS422

Control inputs	Input circuit
Input level High	>0.7 UB
Input level Low	<0.3 UB
Input resistance	10 kΩ

EN580E.ML-TT14.GA11G.13120.H

Through hollow shaft, optical multiturn encoders 13 bit ST / 12 bit MT, SSI

Article number: 11246062

Dimensions

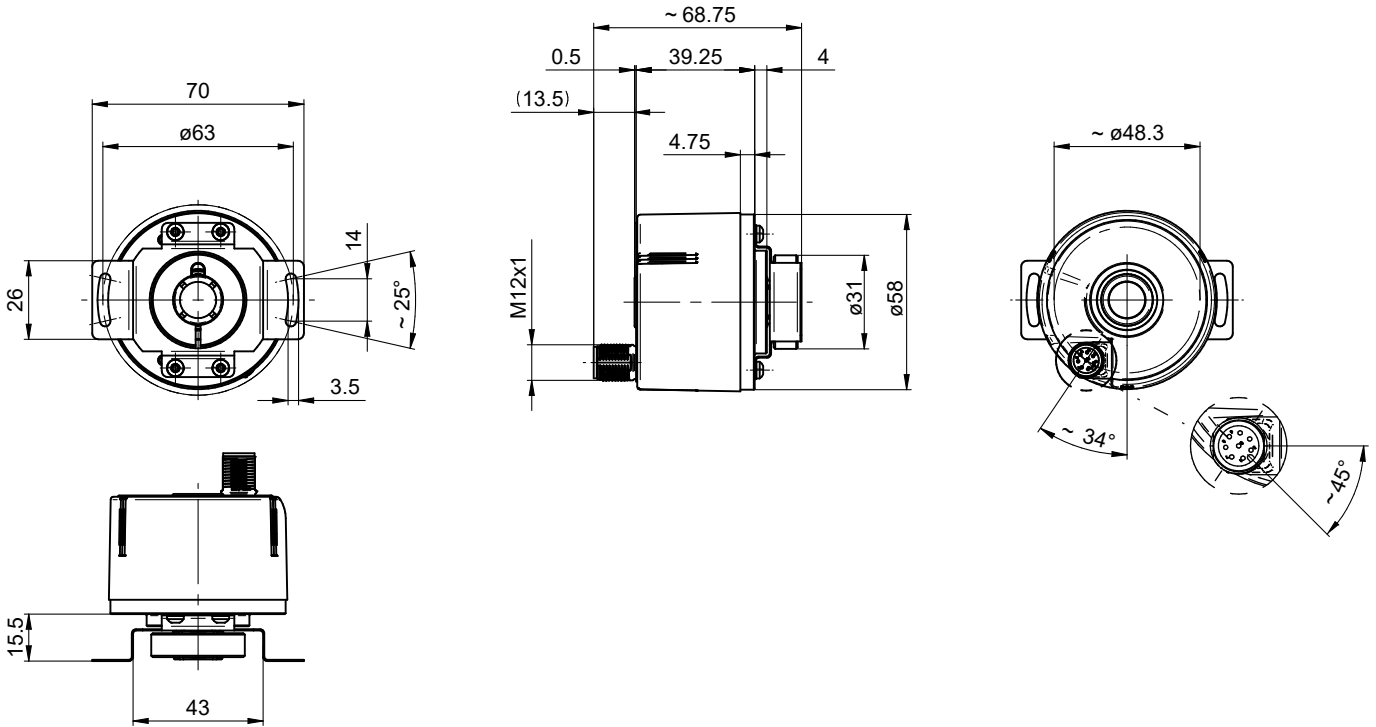

Through hollow shaft, connector M12

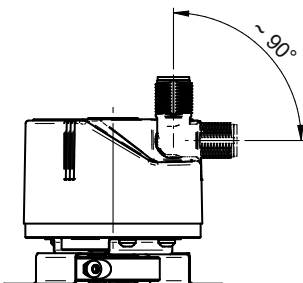

Through hollow shaft, flexible connector M12

Accessories**Mounting accessories**

11066083	Mounting kit 006
11073119	Mounting kit 021
11067367	Mounting kit 028
11100198	Mounting kit 046
11113210	Mounting kit 047
11124300	Mounting kit 048
11106627	Fan cover clip 8 mm
11116921	Insulating sleeve \varnothing 10 mm/ \varnothing 12 mm/25 mm long
11116923	Insulating sleeve \varnothing 12 mm/ \varnothing 14 mm/25 mm long