



Ultrasonic Flowmeter stationary · portable for liquids



measuring
·
monitoring
·
analysing

DUC

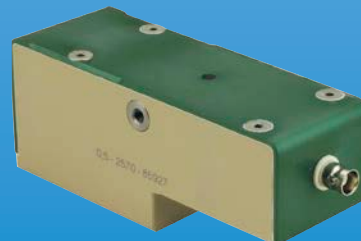
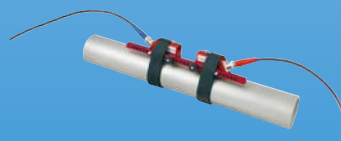

- Media: ultrasonic conducting liquids
- Temperature measuring range: -40 ... 150 °C
- Accuracy: up to 1%
- Flow velocities: 0 ... ±30 m/s
- Pipe sizes: DN 10 ... DN 6000
- For the most common materials (ultrasonic conductive) like steel and plastics
- Heat quantity measurement

SS

KOBOLD companies worldwide:

AUSTRALIA, AUSTRIA, BELGIUM, BULGARIA, CANADA, CHINA, CZECHIA, FRANCE, GERMANY, GREAT BRITAIN, HUNGARY, INDIA, INDONESIA, ITALY, MALAYSIA, MEXICO, NETHERLANDS, PERU, POLAND, REPUBLIC OF KOREA, RUSSIA, SPAIN, SWITZERLAND, THAILAND, TUNISIA, TURKEY, USA, VIETNAM

KOBOLD Messring GmbH
Nordring 22-24
D-65719 Hofheim/Ts.
Head Office:
+49(0)6192 299-0
+49(0)6192 23398
info.de@kobold.com
www.kobold.com



Description

DUC uses the effect of acceleration and deceleration of acoustic signals travelling in a moving liquid. Two ultrasonic clamp-on transducers are mounted (from outside) on a pipe and produce an acoustic path. The transducers send and receive acoustic signals and the transit times t_1 and t_2 are measured by an electronic flow transmitter. The signal from transducer A towards transducer B is accelerated by the flow (short t_1). The return signal from transducer B to transducer A is decelerated by the flow (longer t_2). The difference between t_1 and t_2 together with the path length L can be used to determine the average flow velocity. This principle is known as the acoustic time-of-flight principle. The flow is calculated from the geometry data of the pipe and the flow velocity.

DUC emits a coded signal pattern into the pipe. The received signals will be compared with the sent signals and only the signal pattern which correlates with the original one will be used for flow calculation (cross correlation based signal evaluation). The calculation of the flow is done with the integrated DSP (digital signal processor). Thus the calculation has high sampling rates.

The DSP calculation of the time-of-flight is a pure digital transit time measurement, it works very precise, is completely drift and maintenance free and there is no need for recurring calibrations.

Applications Areas

- Power plants (cooling water), district heating, pump protection, condensate and boiler feedwater measurements
- Water and waste water industry (treatment plant inflow), treatment plant outflow, drinking water networks, verification of water meters, pump protection, distribution and consumption measurements, leakage detection
- Facility management (hot and cold water, cooling systems and air conditioning systems, optimisation of energy efficiency, pump control, optimisation of heating and air conditioning)
- Chemical and petrochemical industry (crude oil and light oil), raw and waste water, aggressive and toxic media, measurement of heat carriers (e.g. thermal oils)
- Food and beverage (correct hygienic measurement of media, heat volume measurement in energy supply)

Features

- Clear text based user interface with LED backlight QVGA display
- User interface control with 6 soft buttons
- Quick-Mount-System with space bar for ultrasonic transducers 1 MHz and 4 MHz
- AFC compensation algorithm: compensates influences of changing media temperatures to the ultrasonic transducer distance
- Reynolds compensation: compensates influences of media viscosity on the ultrasonic measurement
- Ultrasonic transducers AND technology: reducing signal echoes and dispersion effects and having a positive effect on the signal to noise ratio
- 2 channel operation (only with stationary transmitter)

Flow Transmitter

DUC-xP portable flow transmitter

The flow measurement, thermal output and heat quantity measurement is possible for one measurement point with a pair of ultrasonic transducers in combination with a pair of PT100 temperature sensors. Other features of DUC-xP transmitter are battery operation, integrated data logger and a stable aluminium/ABS housing.

DUC-xF stationary 1-channel flow transmitter

Flow measurement, thermal output and heat quantity measurement is applicable for one measurement point in combination with one pair ultrasonic transducers and one pair PT100.

DUC-xF stationary 2-channel flow transmitter

Flow measurement is applicable for one or two different measurement points with two pairs of ultrasonic transducers. DUC-xF 2-channel version supports different mathematical operations like $CH1+CH2$, $CH1-CH2$, $(CH1+CH2)/2$; due to the appliance of two pair ultrasonic-transducers mounted. Opposite mounting of 2 pairs of transducers on the same pipe will increase the accuracy of measurement, a redundancy operation is possible and disruptive influences of gaseous flow profile will be compensated. Thermal output and heat quantity measurement is only supported in operation mode $(CH1+CH2)/2$.

Ultrasonic Transducers

DUC-W standard ultrasonic transducers

The ultrasonic transducers are mounted onto the piping and transmit and receive the ultrasonic signals that are used in the flow transmitter to calculate the volumetric flow rate.

Ultrasonic transducer DUC-Wx40 (4 MHz):

Red housing,
 pipe diameters: DN10 ... DN100
 Operating temperature: -40 °C ... 150 °C
 Protection: IP68 (for stationary transducer)
 Material: PEEK/aluminium

DUC-WP40

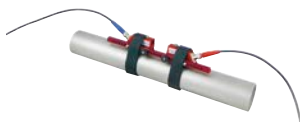

DUC-WF40



Ultrasonic transducer DUC-Wx10 (1 MHz):

Blue housing,
 pipe diameters: DN32 ... DN400
 Operating temperature: -40 °C ... 150 °C
 Protection: IP68 (for stationary transducer)
 Material: PEEK/aluminium

DUC-WP10



DUC-WF10



Ultrasonic transducer DUC-Wx05 (0,5 MHz):

Green housing,
 pipe diameters: DN200 ... DN6000
 Operating temperature: -40 °C ... 150 °C (with stainless steel strap)¹⁾
 -40 °C ... 80 °C (with textile tightening straps)
 Protection: IP68 (for stationary transducer)
 Material: PEEK/aluminium

DUC-WP05



DUC-WF05



Measurement Accuracy for each Channel

Pipe size	Flow velocity	Accuracy
10-25 mm	0...2 m/s	±0.05 m/s
	2...30 m/s	2.5% of reading
25-50 mm	0...2 m/s	±0.03 m/s
	2...30 m/s	1.5% of reading
50-300 mm	0...2 m/s	±0.02 m/s
	2...30 m/s	1% of reading
300-6000 mm	0...2 m/s	±0.02 m/s
	2...30 m/s	1% of reading

¹⁾ **Attention:** stainless steel strap is only for one-time use

Technical Details

Flow transmitter DUC-MF
(stationary)



Flow transmitter DUC-MP
(portable)



	DUC-MF (stationary)	DUC-MP (portable)
Measuring principle	ultrasonic time-of-flight	ultrasonic time-of-flight
Physical Quantities	volume flow, flow velocity, power	volume flow, flow velocity, power
Installation	wallmount	portable
Counter	heat quantity, volume	heat quantity, volume
Measuring range	-30 ... +30 m/s	-30 ... +30 m/s
Signal damping	0 ... 100 s (adjustable)	0 ... 100 s (adjustable)
Diagnostic functions	ultrasonic velocity, signal strength, SNR, signal quality, Amplitude, energy, oscilloscope function for graphical display and evaluation of signal	ultrasonic velocity, signal strength, SNR, signal quality, Amplitude, energy, oscilloscope function for graphical display and evaluation of signal
Human interface	intuitive via 8 soft keys, clear text display	intuitive via 8 soft keys, clear text display
Menu language packages	EN/DE/FR, EN/ES/FR ¹⁾ EN/RU/CHN ¹⁾	EN/DE/FR, EN/ES/FR, EN/RU/CHN
Flow transmitter units	metric/US	metric/US
Outputs	2x4 ... 20 mA, 1 x pulse with 1 channel/ 2x pulse with 2 channel, 1 x micro USB, 1 x relay optional RS232/RS485 (RS485 supports Modbus communication)	2x4 ... 20 mA, 1 x pulse, 1 x micro USB, 1 x relay
Additional inputs for heat measurement	2 x Pt 100	2 x Pt 100
Measuring channels	1, optional 2	1
Power supply	90 - 240 V _{AC} , optional 18-36 V _{DC}	Integrated battery or 100 ... 240 V _{AC} wide range power supply
Battery operation	-	approx. 5 h
Integrated data storage	optional as for DUC-MP	4 GB
Saved data	optional as for DUC-MP	measuring and diagnostic value counter
Data format	optional as for DUC-MP	text format (CSV) directly importable into all popular programs like MS Office, MS Works, etc.
Memory cycle	-	adjustable, 1 s up to 24 h
Protection	IP65	IP40
Cable connections	screw terminals	BNC-connection
Housing	ABS	Aluminium, ABS
Operating temperature	-20 ... 60 °C	-20 ... 60 °C
Dimensions	260 x 240 x 120 mm (W, H, D)	265 x 190 x 70 mm (W, H, D)
Weight	1.3 kg	1.5 kg
Display	QVGA (320 x 240), black and white, adjustable backlight	QVGA (320 x 240), black and white, adjustable backlight
Measuring modes²⁾	CH1, CH2, CH1+CH2, CH1-CH2, (CH1+CH2)/2	-



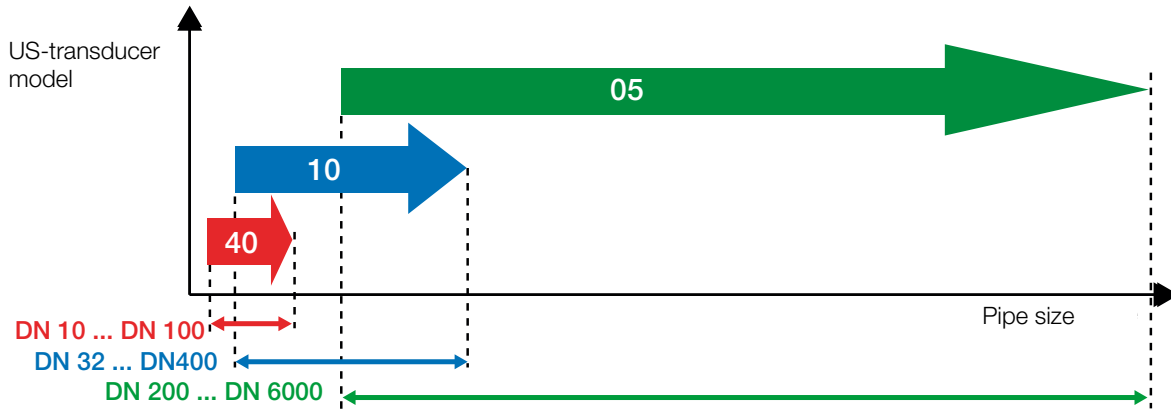

¹⁾ for 1-channel operation only

²⁾ for 2-channel operation only

General Specifications Ultrasonic transducer

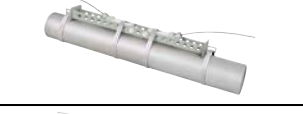

Ultrasonic transducers for transit time measurement

Model	Description	Media temperature	Pipe sizes	
DUC-WP40		portable	-40 ... 150 °C	DN 10 ... DN 100
DUC-WP10			-40 ... 150 °C	DN 32 ... DN 400
DUC-WP05			-40 ... 80 °C -40 ... 150 °C (optional)	DN 200 ... DN 6000
DUC-WF40		stationary	-40 ... 150 °C	DN 10 ... DN 100
DUC-WF10			-40 ... 150 °C	DN 32 ... DN 400
DUC-WF05			-40 ... 150 °C	DN 200 ... DN 6000

Mounting arrangement of the ultrasonic transducer

Mounting in V-mode (standard)

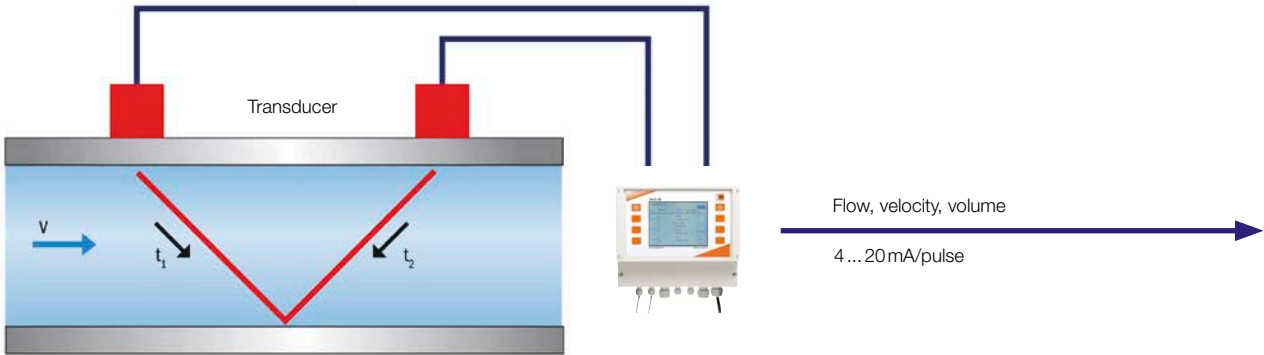

Mounting in Z-mode (applicable for big pipe dimensions or high acoustic damping)

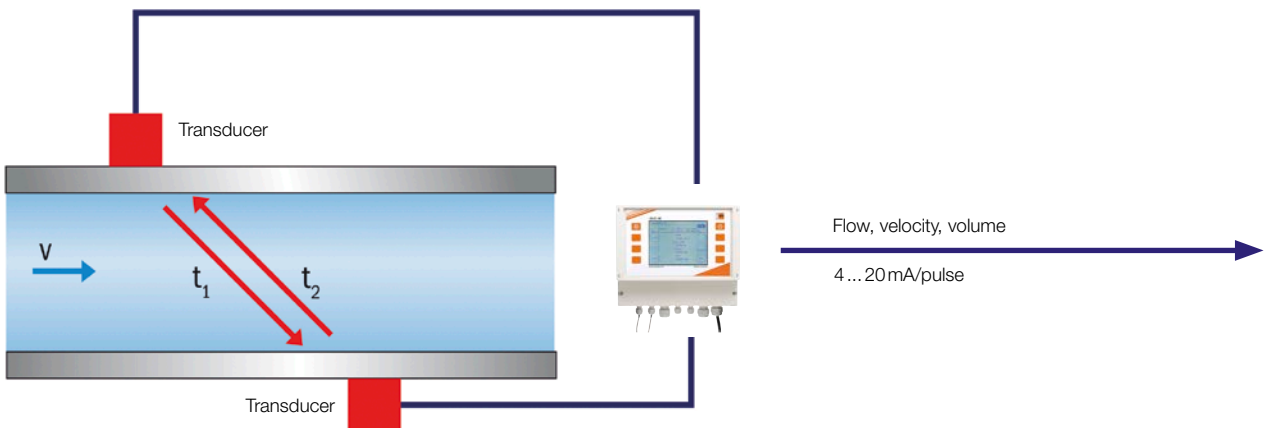

Mounting in W-mode (for pipe dimensions < DN 32)

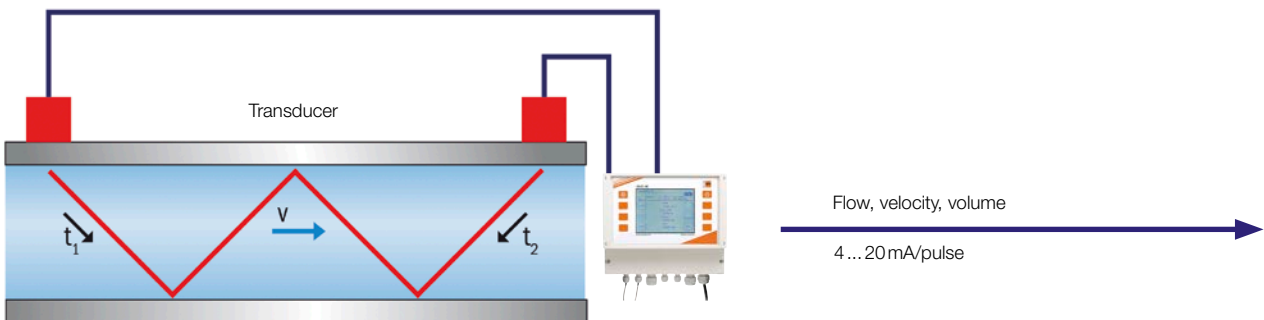

Measuring mode 2-channel system

Simultaneous measurement at 2 different measurement points with two pairs of ultrasonic transducers

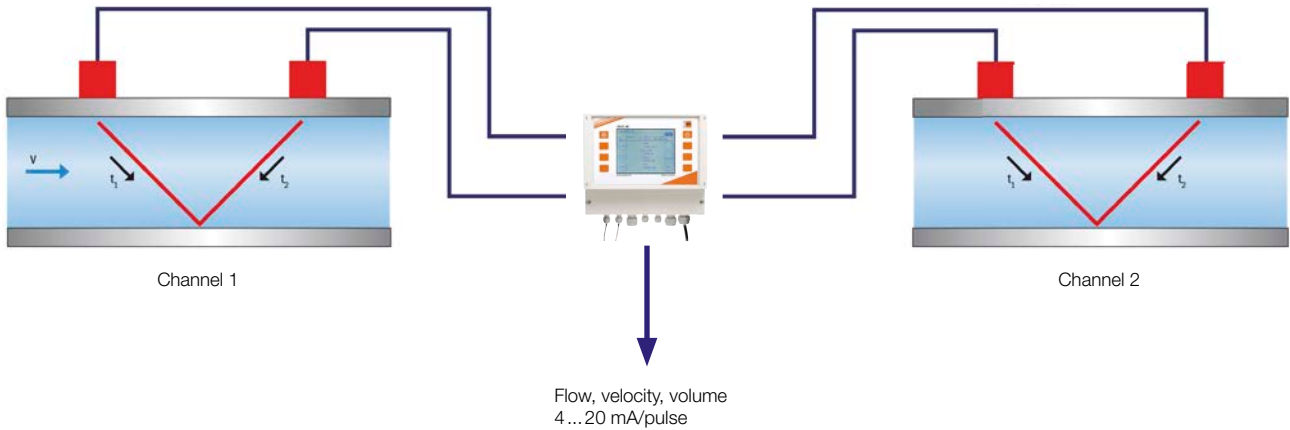

Simultaneous measurement with two pairs of ultrasonic transducers at one common metering point

(Compensation of cross-flow effect on measurement, redundancy operation and higher accuracy)

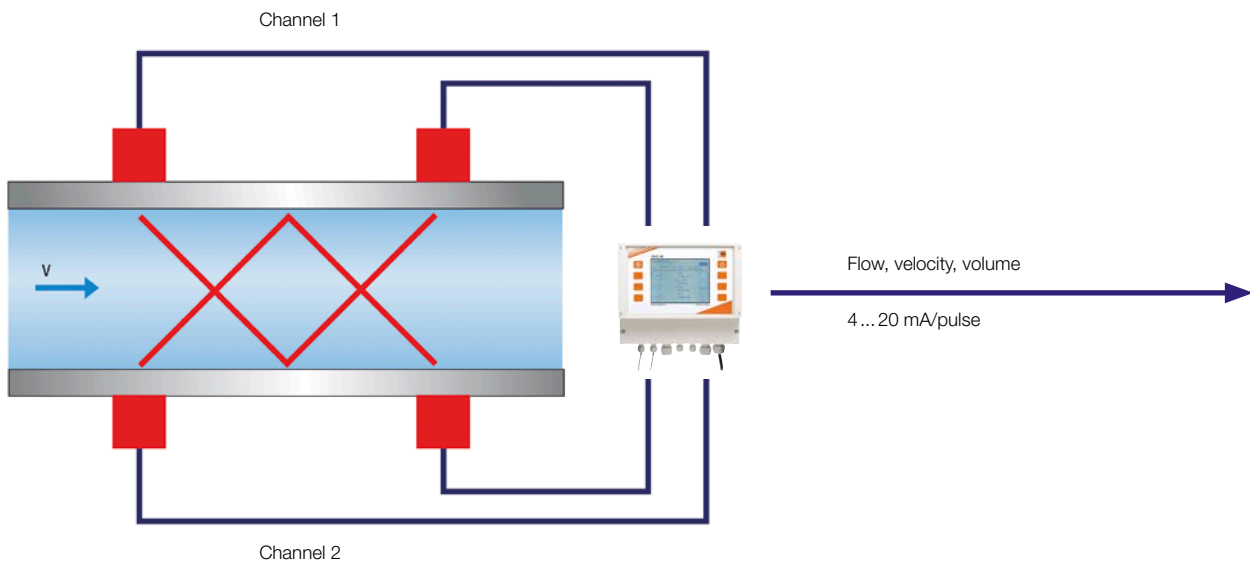

Measurement of heat quantity

DUC-M is more than a flowmeter. Together with external temperature sensors it can also measure the heat transfer of your media. Only two optional Pt 100 have to be connected to DUC-MF for measuring feed/return temperatures (RTD 1/RTD 2) within the heating circuit.

The measured temperature difference and the measured flow Q can then be used to calculate the thermal output and the heat quantity.

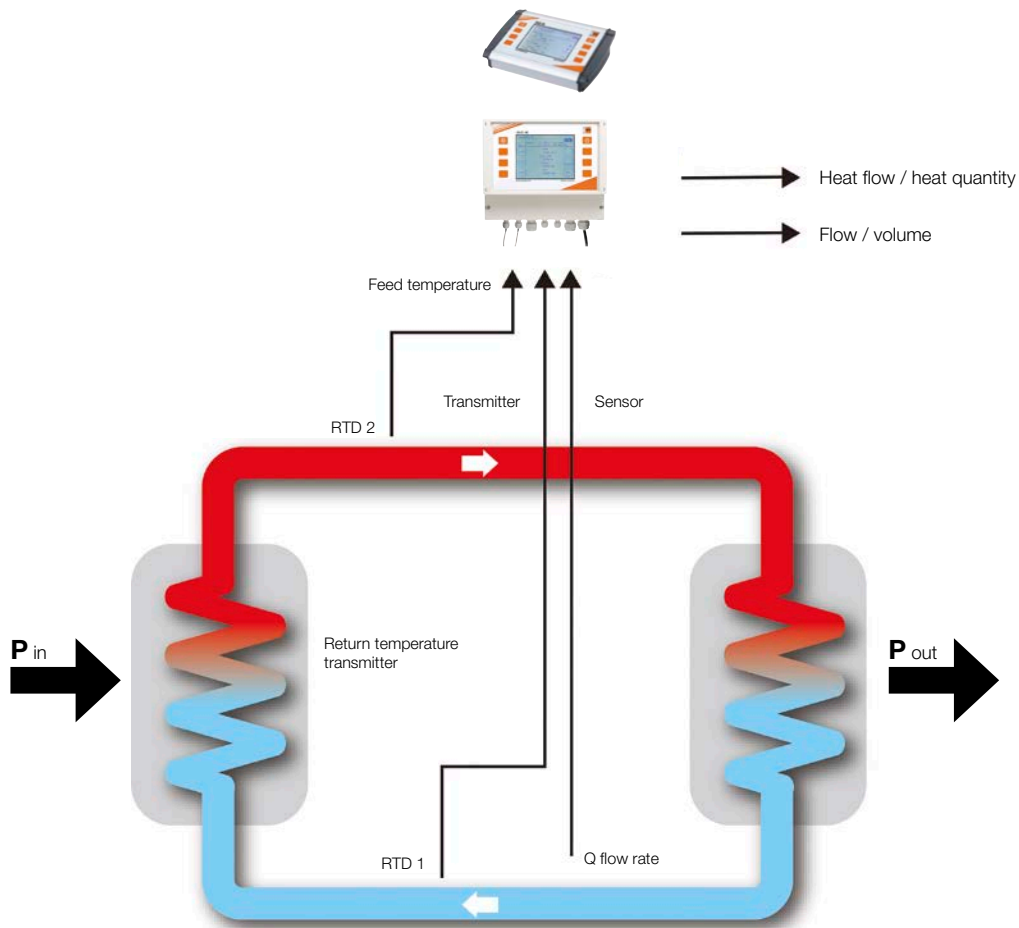



Order Details Transmitter (Example DUC-M F 1 0 0 D R2)

Model	Version	Channel	Supply	Ex-approval	Language packages	Options ²⁾
DUC-M	F = stationary	1 = 1-channel 2 = 2-channel	0 = 90... 240 V _{AC} 7 = 18... 36 V _{DC}	0 = none E = ATEX Exd (suitable for zone 1 and 2) (on request)	D = EN/DE/FR S = EN/ES/FR ¹⁾ C = EN/RU/CHN ¹⁾	00 = none R2 = RS232 R4 = RS485 RL = data logger
	P = portable	1 = 1-channel	0 = 100... 240 V _{AC}	0 = none		00 = none

¹⁾ Only with 1-channel

²⁾ Combination of option R2 with RL or option R4 with RL can be ordered

Order Details Transducer (Example DUC-W F 40 0 10)

Model	Version	Frequency (NW)	Ex-approval	Cable length
DUC-W	F = stationary V ¹⁾ = stationary, PVC	40 = 4 MHz (DN10... DN100) 10 = 1 MHz (DN32... DN400) 05 = 0,5 MHz (DN200... DN6000)	0 = none E = ATEX Exd (suitable for zone 1 and 2) ^{1) 2)}	10 = 10 m 20 = 20 m 30 = 30 m 40 = 40 m 50 = 50 m XX ³⁾ = other (multiple of 10 m)
	P = portable		0 = none	03 ⁴⁾ = 3 m

¹⁾ On request ²⁾ Not for PVC transducer ³⁾ Max. length 250 m

⁴⁾ If the transducer is ordered as a spare part, the cable is **not** included in the scope of delivery

Delivery Scope for portable Transmitter

Following accessories are included in shipment:

1. Hard-shell carrying case
2. Operating manual on CD, Quickstart printed
3. Analogue output cable MiniDIN, crocodile clips 0.5 m
4. Relay / pulse output cable MiniDIN crocodile clips, 0.5 m
5. USB cable
6. Signal cable (1 pair), BNC-connection, 3 m
7. Measuring tape



Delivery Scope for Transducer (portable and stationary)

Following accessories are included in shipment:

1. Mounting rail (not for DUC-Wx05)
2. Coupling foil for stationary, ultrasonic coupling gel for portable device
3. Suitable mounting accessories, such as strap or chains, depending on the transducer type



Order Details Accessories / Spare Parts (Example DUC-Z F P1)

Model	Version	Description
DUC-Z	F = stationary	<p>MS = mounting rails suitable for transducer DUC-WF10 (max. DN400), max.150 °C</p> <p>PT = PT100, surface contact, 1 pair, cable length 5 m, incl. stainless steel strap up to DN 900</p> <p>P1 = PT100, surface contact, 1 pair, cable length 10 m, incl. stainless steel strap up to DN 900</p> <p>P2 = PT100, surface contact, 1 pair, cable length 20 m, incl. stainless steel strap up to DN 900</p> <p>WK = factory calibration 1 MHz or 4 MHz, 5-point on pipe size DN50 WR = factory recalibration 1 MHz or 4 MHz 5-point on pipe size DN50</p> <p>10 = coupling foil 2 pair for DUC-WF10 21 = coupling foil 2 pair for DUC-WF40 05 = coupling foil 1 pair for DUC-WF05</p> <p>SB = short mounting rails (spacer short bar) suitable for DUC-WF40, max. 150 °C</p> <p>EB = stainless steel strap (1 pair) suitable for ultrasonic transducer DUC-WF40, DUC-WF10 (max. DN400)</p> <p>BE = stainless steel strap (1 pair) suitable for ultrasonic transducer DUC-WF05</p> <p>DE = venting unit for gaseous liquids, pipe connection max. DN25</p>
	P = portable	<p>KG = ultrasonic coupling gel, tube, 21 g</p> <p>MS = mounting rails suitable for transducer DUC-WP10 (max. DN400), max.150 °C</p> <p>SB = short mounting rails (spacer short bar) suitable for DUC-WP40, max. 150 °C</p> <p>MK = clamping chains (1 pair) suitable for DUC-WP10 (max. DN400), max. 150 °C</p> <p>BT = textile tightening straps suitable for transducer DUC-WP05, max. 80 °C</p> <p>PT = PT100, 1 pair, MiniDIN, cable length 5 m, incl. stainless steel strap up to DN 900</p> <p>WK = factory calibration 1 MHz or 4 MHz 5-point on pipe size DN50 WR = factory recalibration 1 MHz or 4 MHz 5-point on pipe size DN50</p>
	U	<p>WD = wall thickness gauge (Universal) <i>Technical details see description DUC-ZUWD</i></p>



Description DUC-ZUWD

With the precise wall thickness gauge DUC-ZUWD reliable measurements of pipe wall thicknesses become a matter of minutes. Switch on, put in your pipe data and press transducer onto your pipe – that's it.

DUC-ZUWD determines the thickness of a structure or a pipe by accurately measuring the time required for an ultrasonic signal to travel through the thickness of the material, reflect from the back or inside surface, and be returned to the transducer. The measured two-way transit time of the ultrasonic together with the specific speed of sound of your material is used to accurately measure the wall thickness. The resolution is 0.1 mm!

The light-weight and robust transmitter makes DUC-ZUWD the perfect instrument for harsh environments within the process industry and therefore also a reliable and useful accessory for your clamp-on ultrasonic flowmeter DUC.

The long-life battery mode gives you the independence you need for your measurements. The integrated calibration sample ensures best possible accuracy and high repeatability.

Technical Details

Measuring principle:	ultrasonic transit time
Measuring range:	0.75 ... 80 mm (steel)
Accuracy:	±(0.5 % of thickness + 0.04 mm)
Operating temperature:	-20 ... +70 °C
Ultrasonic transducers:	7 MHz
Supported materials:	all common pipeline materials (sound conductive, e.g. PVC, PE, steel, copper, etc.)
Display:	128x64 LCD with backlight
Resolution:	0.1mm
Measuring units:	metric and US
Languages:	DE, GB, IT, FR, ES
Housing material:	aluminium
Power supply:	2x mignon type AA 1.5V
Dimensions:	132x76,2x32mm (HxWxD)
Weight:	345g



Dimensions [mm]

Transmitter DUC-MF (stationary)

Front



Side

up

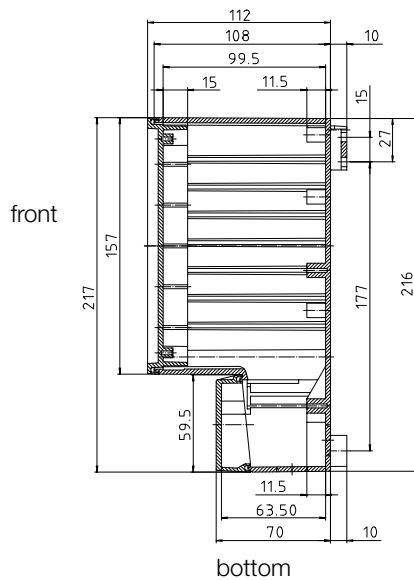

front

bottom

Bottom

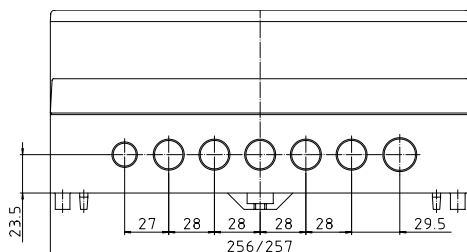

Transducer DUC-WF (stationary)

4 MHz

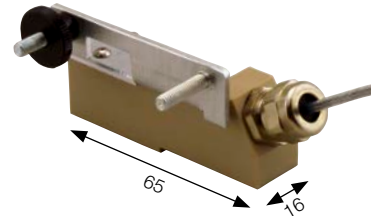

1 MHz

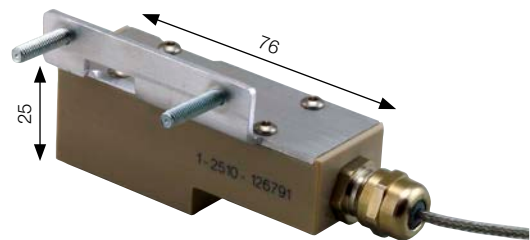

0,5 MHz

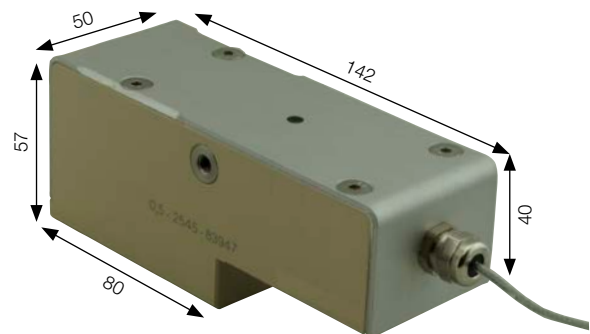

Weights

Model		Weight
Transmitter DUC-MF		1300 g
Transducer DUC-WF	4 MHz	45 g
	1 MHz	50 g
	0.5 MHz	100 g

Dimensions [mm] (continuation)

Transmitter DUC-MP (portable)



Transducer DUC-WP (portable)

4 MHz

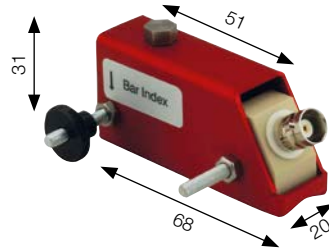

1 MHz

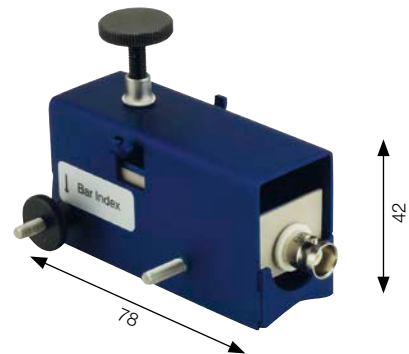

0,5 MHz

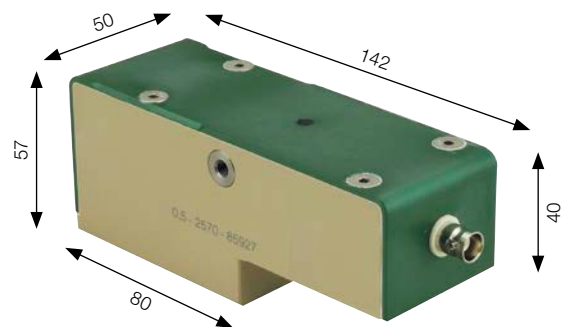

Backside of aluminium body

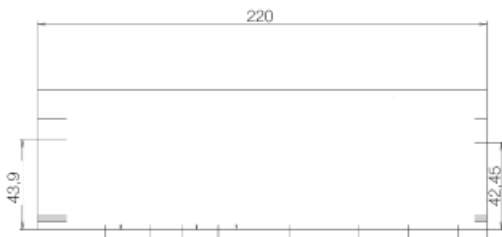

Sideview of aluminium body, including cover plate

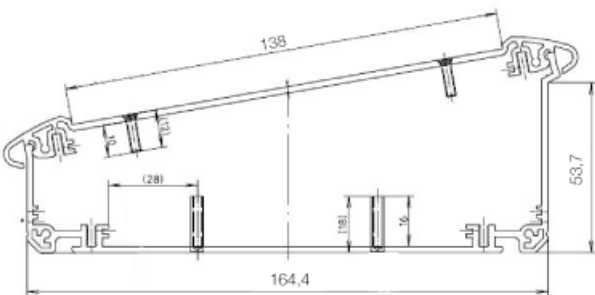

Weights

Model		Weight
Transmitter DUC-MP		1500 g
Transducer DUC-WP	4 MHz	45 g
	1 MHz	50 g
	0.5 MHz	100 g