

DMK 351

Pressure Transmitter

Ceramic Sensor

accuracy according to EN IEC 62828-2:
standard: 0.35 % span
option: 0.25 % span



Nominal pressure

from 0 ... 40 mbar up to 0 ... 20 bar

Output signal

2-wire: 4 ... 20 mA

3-wire: 0 ... 10 V

others on request

Product characteristics

- ▶ high media resistance



Optional versions

- ▶ IS-version (temperature class T4)
Ex ia = intrinsically safe for gases and dusts
- ▶ IS-version (temperature class T6)
- ▶ diaphragm 99.9 % Al₂O₃
- ▶ customer specific versions

The pressure transmitter DMK 351 has been specially designed for applications in plant and machine engineering as well as laboratory techniques and is suitable for measuring small system pressure and filling heights.

By using our own-developed capacitive sensor, optionally available as Al₂O₃ 99.9%, the DMK 351 offers a high overpressure resistance and a high temperature and media resistance. The pressure transmitter is available in an intrinsically safe version for a use in explosive environments.

Preferred areas of use are

-  Plant and Machine Engineering
-  Laboratory Techniques

Preferred used for

-  Fuel and Oil
-  Water



Pressure ranges																
Nominal pressure ¹	[bar]	0.04	0.06	0.1	0.16	0.25	0.4	0.6	1	1.6	2.5	4	6	10	16	20
Level	[mH ₂ O]	0.4	0.6	1	1.6	2.5	4	6	10	16	25	40	60	100	160	200
Overpressure	[bar]	2	2	4	4	6	6	8	8	15	25	25	35	35	45	45
Low pressure	[bar]	-0.2		-0.3		-0.5						-1				
¹ available in gauge and absolute; nominal pressure ranges absolute from 1 bar																
Output signal / Supply																
Standard	2-wire:	4 ... 20 mA / V _S = 9 ... 32 V _{DC}														
Option IS-protection	2-wire :	4 ... 20 mA / V _S = 14 ... 28 V _{DC}														
	Option 3-wire:	0 ... 10 V / V _S = 12.5 ... 32 V _{DC}														
Performance																
Accuracy ¹	standard:	≤ ± 0.35 % span														
	option for P _N ≥ 0.6 bar:	≤ ± 0.25 % span														
Permissible load	current 2-wire R _{max} = [(V _S - V _{Smin}) / 0.02 A] Ω	voltage 3-wire: R _{min} = 10 kΩ														
Influence effects	supply:	0.05 % span / 10 V														
	load:	0.05 % span / kΩ														
Long term stability	≤ ± 0.1 % span / year at reference conditions															
Turn-on time	700 msec															
Mean measuring rate	5/sec															
Response time	mean response time:	< 200 msec										max. response time:	380 msec			
¹ accuracy according to EN IEC 62828-2- limit point adjustment (non-linearity, hysteresis, repeatability)																
Thermal errors (Offset and Span)																
Tolerance band	≤ ± 0.1 % span / 10 K in compensated range: -20 ... 80 °C															
Permissible temperatures																
Permissible temperatures	medium*:	-40 ... 125 °C														
	electronics / environment:	-40 ... 85 °C														
	storage:	-40 ... 100 °C														
<i>*for pressure port in PVDF the medium temperature is -30 ... 60 °C</i>																
Electrical protection																
Short-circuit protection	permanent															
Reverse polarity protection	no damage, but also no function															
Electromagnetic compatibility	emission and immunity according to EN 61326															
Mechanical stability																
Vibration	10 g RMS (20 ... 2000 Hz) according to DIN EN 60068-2-6															
Shock	100 g / 1 msec according to DIN EN 60068-2-27															
Materials																
Pressure port	standard:	stainless steel 1.4404 (316L)														
	option ³ :	PP, PVDF														
Housing	standard:	stainless steel 1.4404 (316L)														
	option ³ :	PP, PVDF														
Option field housing	stainless steel 1.4305 (304); cable gland M16x 1.5, brass, nickel plated (clamping range 2...8 mm)															
Seal (media wetted)	FKM EPDM															
Diaphragm	standard:	ceramics Al ₂ O ₃ 96 %														
	option:	ceramics Al ₂ O ₃ 99.9 %														
Media wetted parts	pressure port, seals, diaphragm															
³ only with mech. connection G1/2" DIN 3852 open port, bore 12 mm, P _N ≤ 10 bar, min. permissible temperature -30 °C and without IS-protection possible																
IS-protection (only for 4 ... 20 mA / 2-wire)																
Approval DX4-DMK 351	IBExU05ATEX1069 X															
	zone 0:	II 1G Ex ia IIC T4 Ga										option:	II 1G Ex ia IIC T6 Ga			
	zone 20:	II 1D Ex IIIC T110°C Da														
Safety technical maximum values	U _i = 28 V _{DC} , I _i = 93 mA, P _i = 660 mW, C _i = 14 nF, L _i negligible, C _{gnd} = 27 nF															
Max. permissible temperature for environment	in zone 0:	-20 ... 60 °C for p _{atm} 0.8 bar up to 1.1 bar														
	in zone 1 and higher:	-25 ... 70 °C														
	for T6:	-25 ... 60 °C														
Connecting cables (by factory)	Cable capacity: signal line / shield also signal line / signal line: 220 pF/m Cable inductance: signal line / shield also signal line / signal line: 1.5 µH/m															
Miscellaneous																
Installation position	any															
Current consumption	signal output current:	max. 21 mA										signal output voltage:	max. 5 mA			
Weight	min. 200 g															
Operational life	> 100 x 10 ⁸ loading cycles															
CE-conformity	EMC-directive: 2014/30/EU															
ATEX Directive	2014/34/EU															

Wiring diagram

2-wire-system (current)

3-wire-system (current / voltage)

Pin configuration

Electrical connection	ISO 4400	Binder 723 (5-pin)	M12x1 (4-pin)	field housing	cable colours (DIN 47100)
Supply +	1	3	1	Vs +	wh (white)
Supply -	2	4	2	Vs -	bn (brown)
Signal + (only for 3-wire)	3	1	3	S +	gn (green)
Shield	ground contact	5	4	GND	ye/gn (yellow / green)

Electrical connections (dimensions in mm)

standard

options

⁴ standard: 2 m PVC-cable without ventilation tube (permissible temperature: -5 ... 70°C), optional cable with ventilation tube
⁵ different cable types and lengths available, permissible temperature depends on kind of cable

Mechanical connection (dimensions in mm)

standard

options

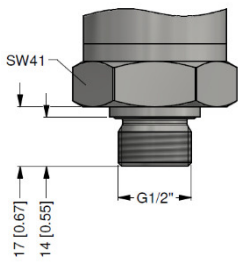

G1/2" DIN 3852

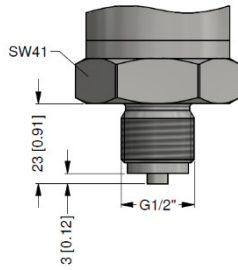

G1/2" EN 837

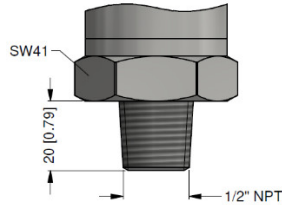

1/2" NPT

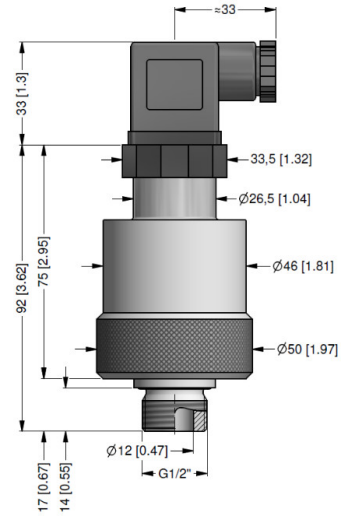

PP / PVDF
G1/2" DIN 3852 open port,
bore 12 mm, P_N ≤ 10 bar

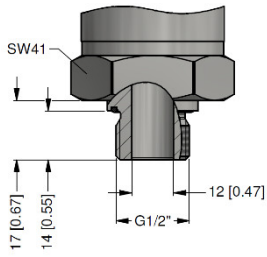

housing and pressure port in stainless steel

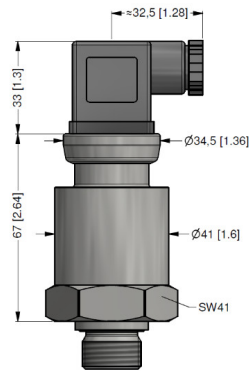

dimensions in mm

This data sheet contains product specification. Properties are not guaranteed. Subject to change with notice.

Ordering code DMK 351

9.12.2020
DMK 351

- - -

Pressure			
Gauge	2	9	0
Absolute ¹	2	9	1
Measured value in m H2O	2	9	2
Input	[mH ₂ O]	[bar]	
0 ... 0,4	0 ... 0,04		0 4 0 0
0 ... 0,6	0 ... 0,06		0 6 0 0
0 ... 1	0 ... 0,1		1 0 0 0
0 ... 1,6	0 ... 0,16		1 6 0 0
0 ... 2,5	0 ... 0,25		2 5 0 0
0 ... 4	0 ... 0,4		4 0 0 0
0 ... 6	0 ... 0,6		6 0 0 0
0 ... 10	0 ... 1		1 0 0 1
0 ... 16	0 ... 1,6		1 6 0 1
0 ... 25	0 ... 2,5		2 5 0 1
0 ... 40	0 ... 4		4 0 0 1
0 ... 60	0 ... 6		6 0 0 1
0 ... 100	0 ... 10		1 0 0 2
0 ... 160	0 ... 16		1 6 0 2
0 ... 200	0 ... 20		2 0 0 2
Customer			9 9 9 9
Customer - underpressure			X X X X
Output			
4 ... 20 mA / 2-wire			1
0 ... 10 V / 3-wire			3
Intrinsic safety 4 ... 20 mA / 2-wire			E
Ex nA "n" 4...20 mA / 2 wire (connector 105)			N
Customer			9
Accuracy			
1 % (underpressure)			8
0,5 %			5
0,35 % (standard)			3
0,25 % (P _N ≥ 0,6 bar)			2
1 % including Calibration Certificate			U
0,5 % including Calibration Certificate			T
0,35 % including Calibration Certificate			S
0,25 % including Calibration Certificate (P _N ≥ 0,6 bar)			R
Customer			9
Electrical connection			
Connector DIN 43650 (ISO 4400) (IP 65)			1 0 0
Connector ISO 4400 (IP 65) + silicone seals			1 0 5
Connector Binder 723 5-pin (IP 67)			2 0 0
Cable gland PG7 / cable length specify (IP 67)			4 0 0
+ PVC cable / 1 m			
Connector Buccaneer (IP 68)			5 0 0
Field housing stainless steel, cable gland M16 x 1,5 (IP 67)			8 0 0
Field housing stainless steel, cable gland M20 x 1,5 (IP 67)			8 8 0
Connector DIN 43650 (ISO 4400) - potting compound inside (IP 67)			E 0 0
Cable outlet / cable length specification needed (IP 68) ²			T R 0
+ PVC cable / 1 m			
Connector M12 x 1, 4-pin (IP 67)			M 0 0
Connector M12 x 1, 4-pin (IP 67) - metal			M 1 0
Customer			9 9 9
Mechanical connection			
G 1/2" DIN 3852			1 0 0
G 1/2" EN 837			2 0 0
G 1/4" DIN 3852			3 0 0
M 20 x 1,5 EN 837			8 0 0
1/2" NPT			N 0 0
G 1/2" DIN 3852 open port (P _N ≤ 10 bar)			H 0 0
Customer			9 9 9



Seals					
Viton (FKM)	1				
EPDM ($P_N < 160$ bar)	3				
Customer	9				
Pressure port					
Stainless steel 1.4404 (316 L)	1				
PP (only mech.con. H00) ³	E				
PVDF (only mech.con H00) ³	B				
Customer	9				
Diaphragm					
Ceramic Al ₂ O ₃ 96 %		2			
Ceramics Al ₂ O ₃ 99,9 %		C			
Customer		9			
Special version					
Standard			0	0	0
Customer			9	9	9

0,-...without additional charge

On request...in accordance with the producer

Surcharges for calibration are not subject to any discounts. Subject to change. □

This document contains the specification for ordering the product; detailed technical parameters of the product and its possible variants are given in the data sheet.

BD SENSORS reserves the right to change sensor specifications without further notice.

1 nominal pressure ranges absolute from 1 bar

2 code TR0 = PVC cable, cable with ventilation tube available in different types and lengths; cable not included in the price

3 PP / PVDF possible only with G1/2" DIN 3852 open pressure port, $P_N \leq 10$ bar and without explosion protection; permissible medium temperature: -30 ... 60 °C



BD SENSORS s.r.o.
Hradištská 817
CZ – 687 08 Buchlovice

Tel.: +420 572 411 011
Fax: +420 572 411 497

www.bdsensors.cz
info@bdsensors.cz

The company BD SENSORS s.r.o. is certified by TÜV SÜD Czech according to the standard ISO 9001.

