

GIM500R - 1-dimensional

1-dimensional, measuring range 0...360°

CANopen® / SAE J1939 / Analog

Overview

- Size 52 mm
- MEMS capacitive measuring principle
- E1 compliant design
- Interface CANopen®, SAE J1939, Analog
- Connection M12 and cable
- Protection up to IP 69K
- Applicable up to PLd (ISO 13849)

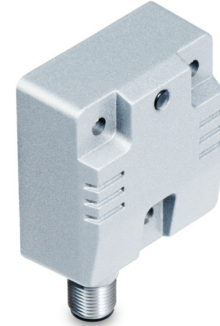

Technical data

Technical data - electrical ratings

Voltage supply	8...36 VDC
Reverse polarity protection	Yes
Consumption w/o load	≤40 mA (24 VDC)
Initializing time	≤ 0.5 s after power on
Interface	CANopen® SAE J1939 Analog (4...20 mA / 0.5...4.5 V / 0...5 V / 0...10 V)
Load resistor	≥1 kΩ / voltage output ≤800 Ω / current output
Measuring range	0...90°, 0...120°, 0...180°, 0...270°, 0...360°
Resolution	0.01 ° CANopen® 0.01 ° SAE J1939 12 bit Analog
Accuracy (+25 °C)	Typ. ±0.1°
Temperature coefficient	0.008 °/K
Repeatability	± 0.1 ° (+25 °C)
Sensing rate	1600 Hz
Limit frequency	0.1...25 Hz, 2. order / low-pass filter (Default: 5 Hz)
Interference immunity	EN 61000-6-2 ECE Reg. No. 10R04 ISO 7637-2 ISO 11452-2 / ISO 11452-5
Emitted interference	EN 61000-6-4 ECE Reg. No. 10R04 ISO 7637-2 / EN 55025

Technical data - electrical ratings

MTTF _d (ISO 13849)	High (>100 years) Use in safety functions exclusively based on Application Note and MTTF _d reliability prediction (request separately).
Programmable parameters	Preset and offset Filter
Diagnostic function	Parameter error
Status indicator	DUO-LED integrated in housing
Approval	UL approval / E63076

Technical data - mechanical design

Dimensions W x H x L	48 x 24 x 52 mm
Protection EN 60529	IP 66 IP 67 IP 68 IP 69K
Material	Housing: aluminium, coated
Corrosion protection	IEC 60068-2-52 Salt mist for ambient conditions CX (C5-M) according to ISO 12944-2
Operating temperature	-40...+85 °C (see general information)
Resistance	EN 60068-2-6 Vibration 20 g, 60-2000 Hz EN 60068-2-27 Shock 200 g, 6 ms
Weight approx.	95 g
Connection	Flange connector M12, 8-pin Flange connector M12, 5-pin Cable 1 m

Optional

- With integrated terminating resistor
- Connection with DEUTSCH connector
- Output signal with out-of-range diagnostics

GIM500R - 1-dimensional

1-dimensional, measuring range 0...360°

CANopen® / SAE J1939 / Analog

General information

Self-heating correlated to installation and ambient conditions as well as to electronics and supply voltage must be considered for precise thermal dimensioning. The inclination sensor is supposed to self-heat to approximately 5 K when attached to a varnished ground metal. Operating the inclination sensor close to the maximum limits requires measuring the currently prevailing temperature at the housing. Vibration with frequency in the range of 1600 Hz acting on the sensor leads to reduced measuring accuracy.

Installation position

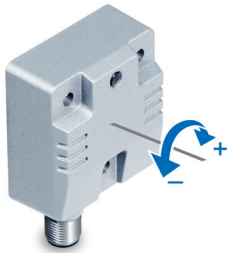

When installing 1-dimensional inclination sensors, make sure the rotational axis as shown in the illustration is in a perpendicular position to the gravity. Maximum misalignment $\pm 3^\circ$.

The 1-dimensional sensor default position is 0° as shown in the following illustration, but may be configured at will using the 2-point-teach or zero setting function.

Default 0°



Measured value 90°

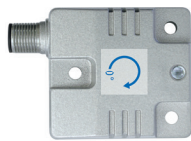

Measured value 180°



Measured value 270°

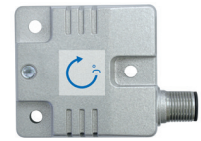

GIM500R - 1-dimensional

1-dimensional, measuring range 0...360°

CANopen® / SAE J1939 / Analog

Terminal assignment

Analog – M12 flange connector, 8-pin

Pin	Assignment	Description
1	+Vs	Voltage supply
2	GND	Ground connection relating to +Vs
3	OUT	Output
4	d.u.	Do not use
5	Teach ¹⁾	Teach-Input
6	d.u.	Do not use
7	d.u.	Do not use
8	A_GND	Ground connection relating to Analog

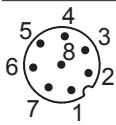

M12 flange connector (male),
A-coded

Analog – cable

Core color	Assignment	Description
White	+Vs	Voltage supply
Brown	GND	Ground connection relating to +Vs
Green	OUT	Output
Yellow	d.u.	Do not use
Grey	Teach ¹⁾	Teach-Input
Pink	d.u.	Do not use
Blue	d.u.	Do not use
Red	A_GND	Ground connection relating to Analog

¹⁾ Function zero setting:

See description zero setting

Function 2-Point-Teach:

See description Teach process

CANopen® / SAE J1939 – M12 flange connector, 5-pin

Pin	Assignment	Description
1	CAN_GND	Ground connection relating to CAN
2	+Vs	Voltage supply
3	GND	Ground connection relating to +Vs
4	CAN_H	CAN Bus Signal (dominant High)
5	CAN_L	CAN Bus Signal (dominant Low)

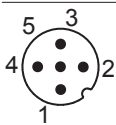

M12 flange connector (male),
A-coded

Terminal assignment

CANopen® / SAE J1939 – 2xM12 flange connector, 5-pin

Pin	Assignment	Description
1	CAN_GND	Ground connection relating to CAN
2	+Vs	Voltage supply
3	GND	Ground connection relating to +Vs
4	CAN_H	CAN Bus Signal (dominant High)
5	CAN_L	CAN Bus Signal (dominant Low)

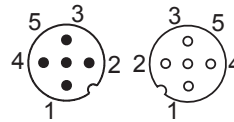

M12 flange connector (male / female),
A-coded

Terminals of the same significance are internally connected and identical in their functions. Max. load on the internal terminal connections Vs-Vs and GND-GND is 1 A each.

CANopen® – Cable

Core color	Assignment	Description
White	+Vs	Voltage supply
Brown	GND	Ground connection relating to +Vs
Green	d.u.	–
Yellow	d.u.	–
Grey	d.u.	–
Pink	CAN_H	CAN Bus Signal (dominant High)
Blue	CAN_L	CAN Bus Signal (dominant Low)
Red	CAN_GND	Ground connection relating to CAN

CANopen® features

Device profile	CANopen® CiA DSP 301 V4.2 Inclinometer profile DS 410 V1.3 LSS service profile DS 305 V2.2
Default	Resolution 0.1° Baud rate 50 kbit/s Node-ID 1

GIM500R - 1-dimensional

1-dimensional, measuring range 0...360°

CANopen® / SAE J1939 / Analog

Output signals

Analog output

Measuring range 0...90°

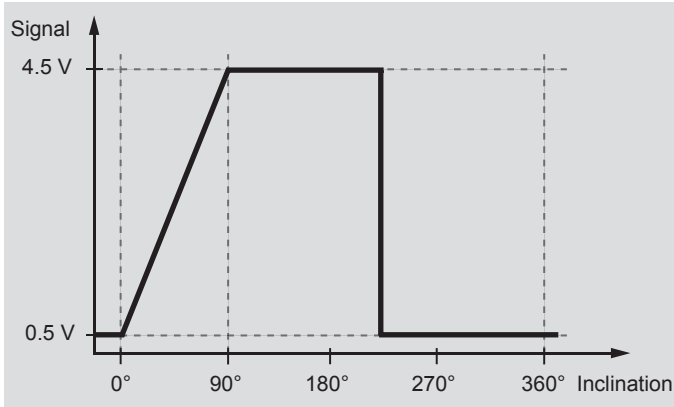

Inclination 0°

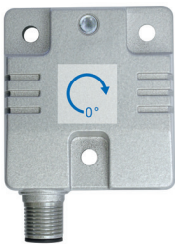

Inclination 90°

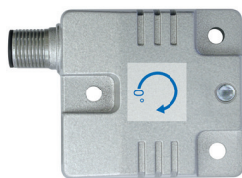

Output signals

Measuring range 0...360°

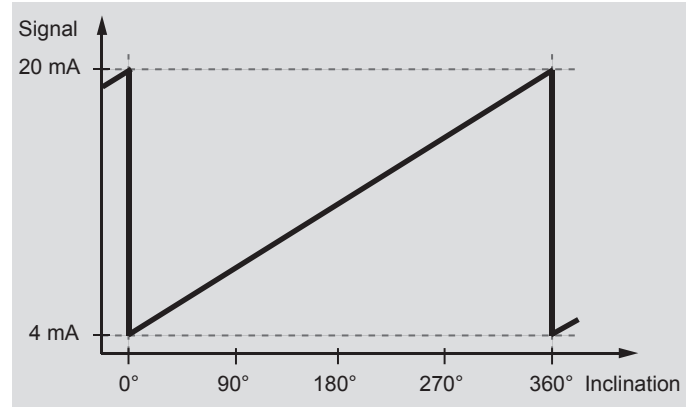

Inclination 0°



Inclination 360°



Measuring range 0...180°

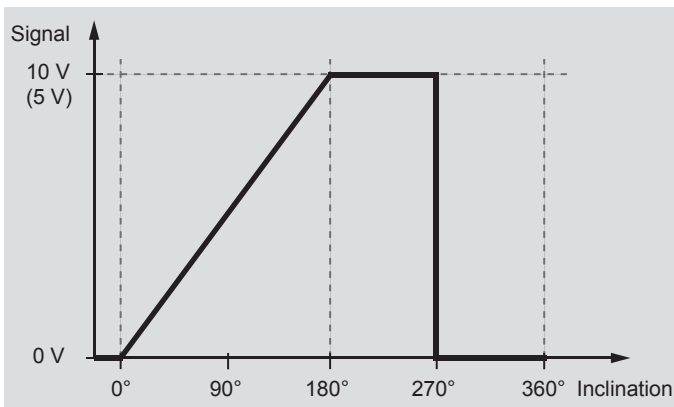

Inclination 0°

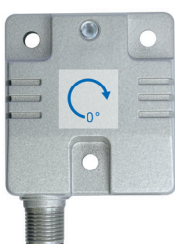

Inclination 180°



GIM500R - 1-dimensional

1-dimensional, measuring range 0...360°

CANopen® / SAE J1939 / Analog

Output signals

Analog output with out-of-range diagnostic (Option: /4822)

Measuring range 0...90°

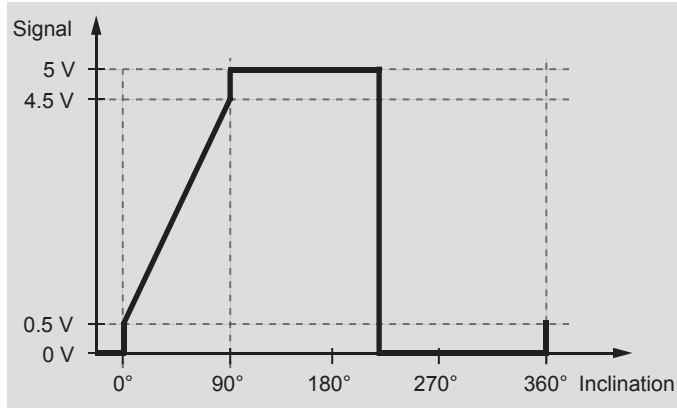

Inclination 0°



Inclination 90°

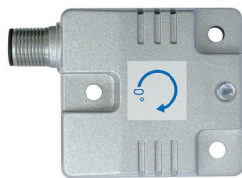

Output signals

Measuring range 0...360°

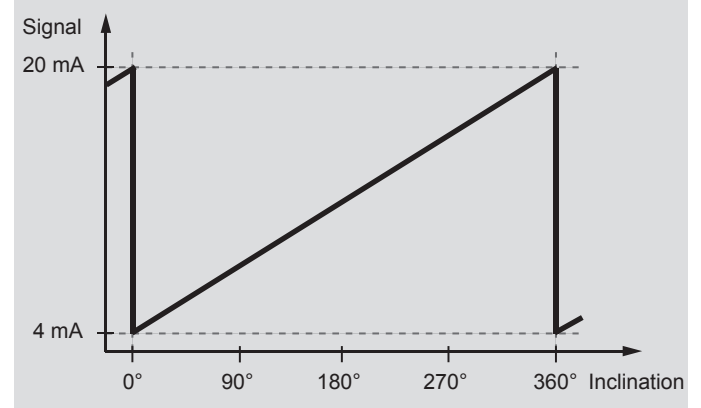

Inclination 0°

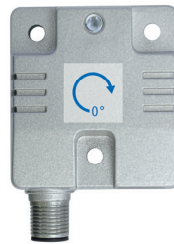

Inclination 360°



Measuring range 0...180°

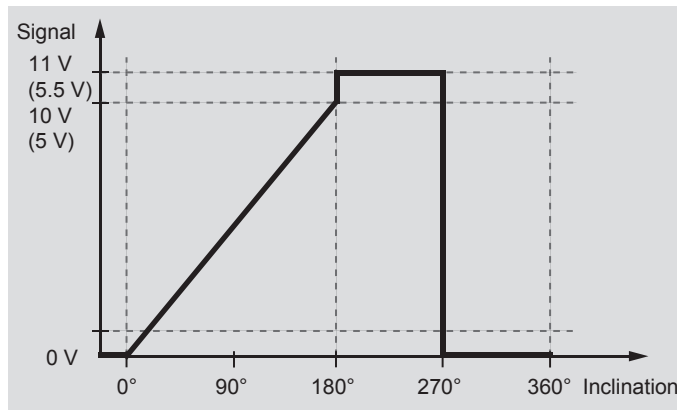

Inclination 0°



Inclination 180°



Teach process**2-Point-Teach****Activate teach process**

Start teach process within 5 minutes after power on. Set teach input for

>5 seconds on HIGH level ($\geq 0.7 \cdot V_s$).

DUO-LED: Oscillates after 5 seconds orange.

Position 1

Get inclination sensor on position intended for min. voltage output / current output. Set teach input for >0.1 seconds on HIGH.

DUO-LED: Lights for 3 seconds orange and afterwards oscillates.

Position 2

Get sensor on position intended for max. voltage output / current output. (Rotational direction of the teaching operation corresponds to rotational direction in the application).

Set teach input for >0.1 seconds on HIGH.

DUO-LED: Lights for 3 seconds orange and afterwards oscillates 3 x green. If measuring range is exceeded or the limits are too close to each other (min. 5° difference), the teaching process was not successful (LED lights 3 x red) and has to be repeated.

Default

Set teach input for >15 seconds on HIGH.

DUO-LED: Oscillates after 5 seconds orange and lights after 15 seconds, 3 seconds orange.

GIM500R - 1-dimensional

1-dimensional, measuring range 0...360°

CANopen® / SAE J1939 / Analog

Dimensions

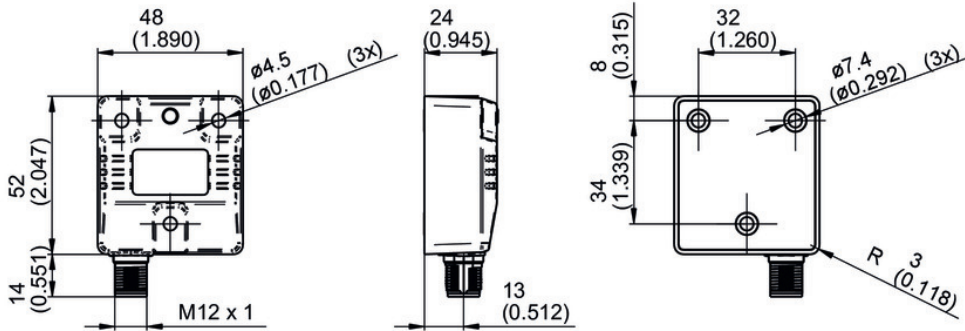

GIM500R - 1 x connector M12

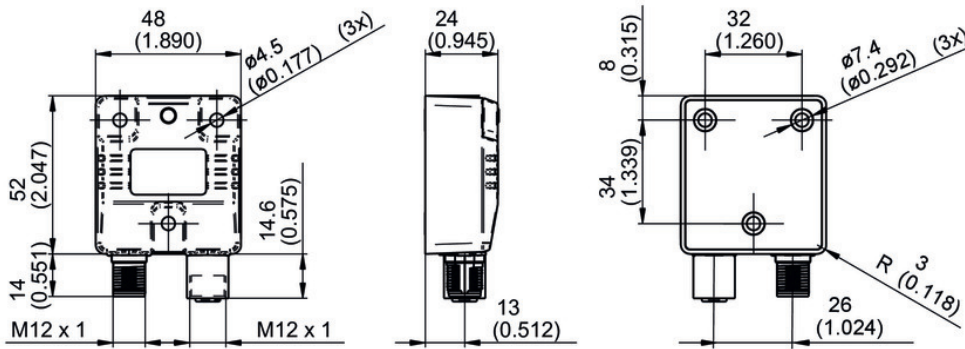

GIM500R - 2 x connector M12

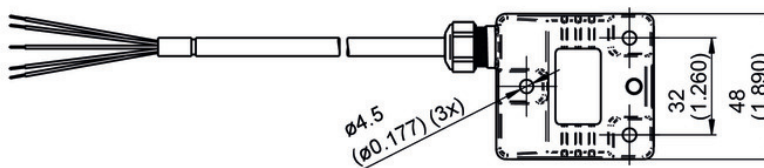
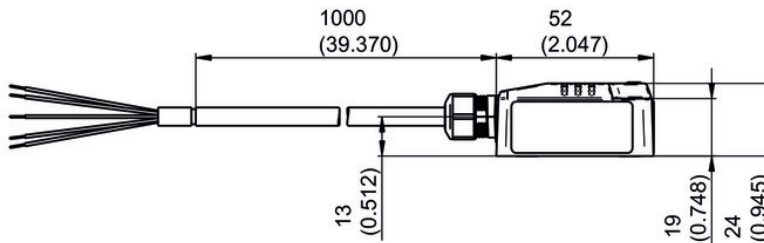
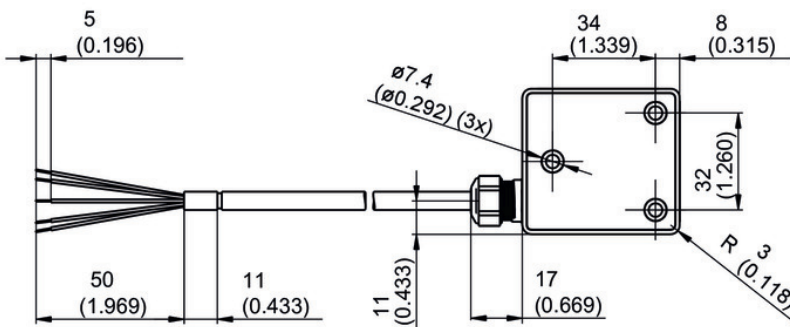

GIM500R - cable

GIM500R - 1-dimensional

1-dimensional, measuring range 0...360°

CANopen® / SAE J1939 / Analog

Ordering reference

	GIM500R	-	M	1	###	.	#	##	.	A	#####
Product	GIM500R										
Housing											
Metal			M								
Number of axes											
1-dimensional				1							
Measuring range											
0...90° (Analog with zero setting)											09
0...120° (Analog with zero setting)											12
0...180° (Analog with zero setting)											18
0...270° (Analog with zero setting)											27
0...360° (Analog with 2-point Teach / CANopen®, SAE J1939)											36
Connection											
Cable 1 m, Standard 4x2x0.14 mm ² (Analog, CANopen®, SAE J1939)											K
Flange connector M12, 5-pin, male contacts (CANopen®, SAE J1939)											A
Flange connector 2xM12, 5-pin, male and female contacts (CANopen®, SAE J1939)											B
Flange connector M12, 8-pin, male contact (Analog)											F
Voltage supply / interface											
8...36 VDC / CANopen®											C6
8...36 VDC / SAE J1939											C9
8...36 VDC / Analog 0.5...4.5 V											V4
8...36 VDC / Analog 0...5 V											V5
8...36 VDC / Analog 0...10 V											V1
8...36 VDC / Analog 4...20 mA											C4
Operating temperature											
-40...+85 °C											A
Option											
Without option											
With integrated terminating resistor (CANopen, SAE J1939)											/4816
Output signal with out-of-range diagnostics (Analog)											/4822

Accessories

Mounting accessories

11120131	Mounting kit 3x M4 x 25 DIN912, A 4.3 DIN125
11189609	Mounting kit 3x M4 x 50 DIN912, A 4.3 DIN125, spacers

Programming accessories

11084376	ZTEST-ALL.ANALOG
11128719	USB-to-CAN V2 Adapter