



SLE-73

- economical pulse counter
- 1 pulse counting input
- 1 programmable function input
- power supply output 24V DC
- prescaler and digital filter
- RS-485 / Modbus RTU
- free configuration software S-Config

The SLE-73 meters have been designed exclusively for applications where a progressive counting of impulses is required. They feature two entry ports: counting and with a programmable function that can be used for resetting the meter to zero or stopping / changing its direction of travel (as required). The built-in entry port divisor with programmable value from 1 to 9999, along with an adjustable decimal point, permits a simple transfer of incoming impulses into the units required. The counter can be configured with the local keyboard or free S-Config software via the RS-485 communication port.

TECHNICAL DATA

Power supply	19V ÷ 50V DC; 16V ÷ 35V AC or 85 ÷ 260V AC/DC or 12V AC/DC, all separated
Power consumption	for 12V AC/DC, 85 ÷ 260V AC/DC and 16V ÷ 35V AC power supply: max. 4.5 VA; for 19V ÷ 50V DC power supply: max. 4.5 W
Display	LED, 6 x 9 mm high, red, brightness adjustable in 8 steps
Displayed values range	-99999 ÷ 999999 + decimal point, with signalling of overfilling
Inputs	pulse, galvanically isolated: - counting down-up and up-down (PNP) - programmable function (PNP) - common (COM)
Input levels	low level: 0 V ÷ 1 V; high level: 10 V ÷ 30 V (12 mA @ 24V)
Input frequency	electronic sensor: 3 kHz contact sensor: max. 90 Hz (adjustable filter)
Power supply output	24V DC +5%, -10% / max. 100 mA, stabilized
Communication interface	RS-485, 8N1 and 8N2, 1200 bit/s ÷ 115200 bit/s, Modbus RTU (not galvanically isolated)
Data memory	non-volatile memory, EEPROM type
Operating temperature	0°C ÷ +50°C (standard), -20°C ÷ +50°C (option)
Storage temperature	-10°C ÷ +70°C (standard), -20°C ÷ +70°C (depending on option)
Protection class	IP 65 (front), optional integrated frame for panel cut-out sealing; IP 20 (case and connection clips)
Case	panel mounting; material: NORYL - GFN2S E1
Dimensions	case (WxHxD): 72 x 36 x 97 mm panel cut-out dimensions: 66.5 x 32.5 mm installation depth: min. 102 mm board thickness: standard 7 mm or other depending on used board thickness brackets (see: Accessories)
Weight	150 g max.



DIMENSIONS

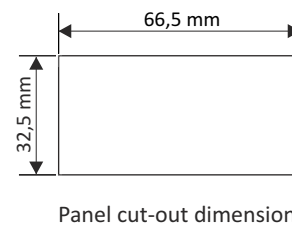
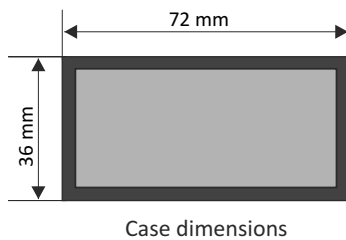
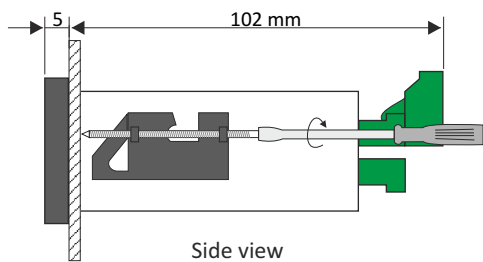

EXAMPLARY PIN ASSIGNMENT

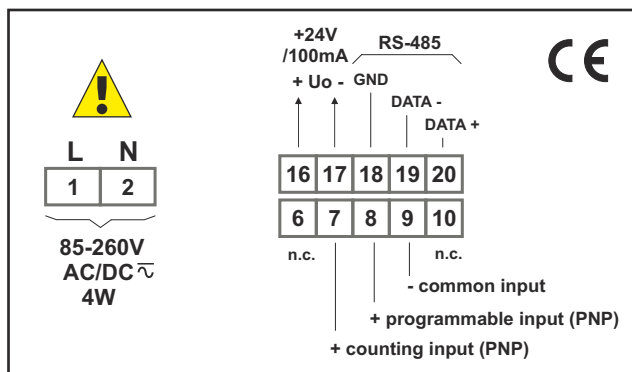

ORDERING

SLE-73-1400-1-X-XX1

options:

- 00 : no options
- 01 : integrated frame for panel cut-out sealing
- 08 : operating temp. -20°C ÷ +50°C
- 0P : integrated frame for panel cut-out sealing + operating temp. -20°C ÷ +50°C

power supply:

- 3 : 24V AC/DC
- 4 : 85V ÷ 260V AC/DC
- 5 : 12V AC/DC



MOUNTING PLATES

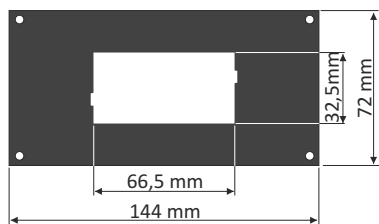

SMP-147/73
maskownica 144 x 72 mm
do montażu urządzeń
w obudowie 72 x 36 mm

BOARD THICKNESS BRACKETS / ADAPTORS



SPH-07
1 ÷ 7 mm board thickness
brackets (2 pcs)
standard included with device



SPH-05
1 ÷ 5 mm board thickness
brackets (2 pcs)



SPH-45
1 ÷ 45 mm board thickness
brackets (2 pcs)

SOFTWARE

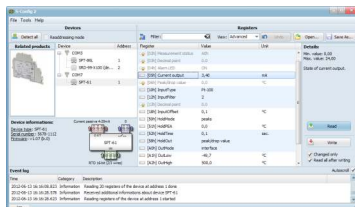

S-Config 2 is used for the simultaneous detection of devices in multiple Modbus RTU networks and allows user to change the configuration of most of them. For each detected device a list of its registers, which the user can modify, is displayed and also additional informations about device parameters (type, address in the network, etc.).

S-Config software can be downloaded from SIMEX website at www.simex.pl

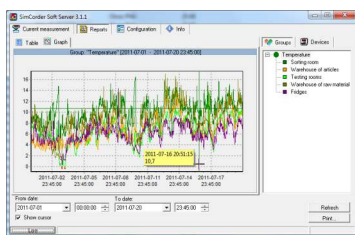

SimCorder Soft is a visualisation application created to facilitate work with advanced networks of the SIMEX devices, for acquisition, visualisation, reporting, archiving, exporting and printing of measurement data from all network devices. You can download measurements from the devices automatically or on demand. There is a possibility of immediate notification about emergency states via SMS or e-mail, which will often allow to quickly resolve an arising problem while avoiding long and expensive stoppages. You can view the measurement data, emergency states and configuration via the internet at every time.

CONVERTERS



The **SRS-U4** converter is designed to connect a USB host to slave devices equipped with RS-485 interface. The PC with special software can be used as a host. The **SRS-U4** unit guarantees full galvanic isolation between USB and RS-485 circuits. The converter can work with any devices equipped with RS-485 interface and contains integrated circuit which supports USB 1.1 and USB 2.0 standards. The main purpose is connection of PC host computer with industrial data acquisition and visualisation systems based on RS-485 interface.

The **SRS-U4** can be also manufactured with DIN mounting adaptor.