

Overview

- 2 mm
- PNP make function (NO)
- flylead connector M8
- -25 ... 75 °C
- IP 67



Picture similar



Technical data

General data		Electrical data	
Mounting type	Flush	Short circuit protection	Yes
Nominal sensing distance S _n	2 mm	Reverse polarity protection	Yes
Hysteresis	3 ... 20 % of S _r	Mechanical data	
Output indicator	LED red	Type	Cylindrical threaded
Electrical data		Material (sensing face)	PBT
Switching frequency	< 5 kHz	Housing material	Stainless steel
Voltage supply range +V _s	6 ... 36 VDC	Dimension	8 mm
Current consumption max. (no load)	12 mA	Housing length	40 mm
Output circuit	PNP make function (NO)	Connection types	Flylead connector M8
Voltage drop V _d	< 2 VDC	Tightening torque max.	10 Nm (Front: 7 Nm)
Output current	< 200 mA	Ambient conditions	
		Operating temperature	-25 ... +75 °C
		Protection class	IP 67

Dimension drawing

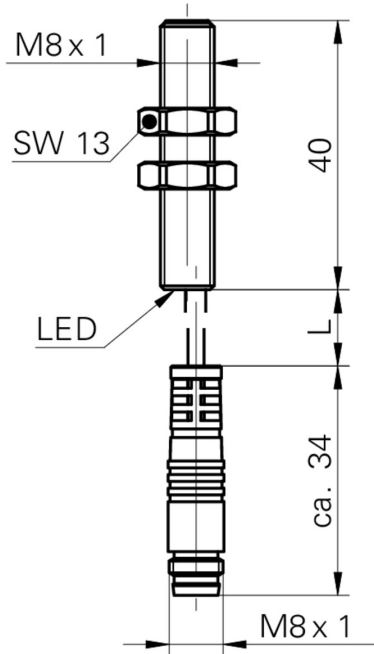

- Standard cable length 200 mm (L)

Connection diagram

