

SCT105



- temperature range $-40 \div 1200^{\circ}\text{C}$ depending on thermocouple
- operating temperature of connection heads max. 100°C
- stainless steel sheath
- MA type connection head
- possibility of mounting a 4...20 mA or 0...10 V temperature transmitter
- outer thermowell with process connection

The thermocouple **SCT105** consists of a non-exchangeable measuring insert, outer protective tube with threaded process connection (thermowell), and aluminum connection head. Miniature connection head MA type reduces the size of complete sensor construction to make possible installation in confined areas.

Application areas:

- fine chemical industry,
- light energy industry,
- general industrial services.

TECHNICAL DATA

Sensing element	J, K, N thermocouple (single, double)
Measuring range	$-40 \div 1200^{\circ}\text{C}$ (depending on thermocouple and material)
Connection head	MA type, aluminum, operating temperature $-40 \div 100^{\circ}\text{C}$
Class	1 or 2
Sheath	material: stainless steel 1.4541 or other nominal length: 100 mm (standard) diameter: 8 mm
Process connection	G1/2", M20x1,5 or other

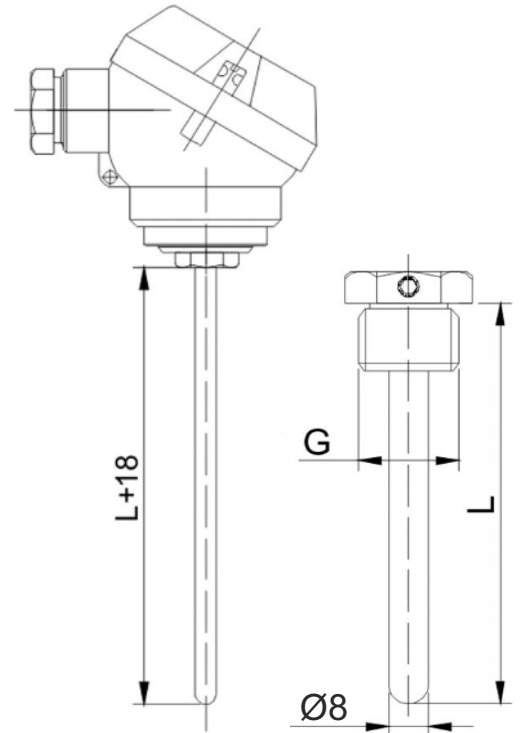

CONNECTION HEAD

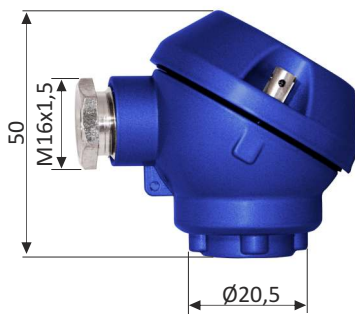

typ MA

THERMOCOUPLES TOLERANCE ACC. TO PN-EN 60584

Thermocouple	Class 1		Class 2	
	Temperature range	Tolerance	Temperature range	Tolerance
J (Fe-CuNi)	$-40 \div 750^{\circ}\text{C}$	$\pm 1,5^{\circ}\text{C}$	$-40 \div 750^{\circ}\text{C}$	$\pm 2,5^{\circ}\text{C}$
K (NiCr-Ni)	$-40 \div 1000^{\circ}\text{C}$	$\pm 0,0040^{\circ}\text{C} \times t $	$-40 \div 1200^{\circ}\text{C}$	$\pm 0,0075^{\circ}\text{C} \times t $
N (NiCrSi-NiSi)	$-40 \div 1000^{\circ}\text{C}$		$-40 \div 1200^{\circ}\text{C}$	



TYPES OF MEASURING HOT JUNCTION

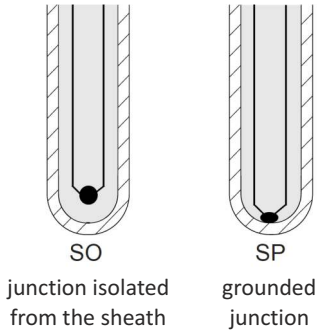

ELECTRICAL CONNECTION

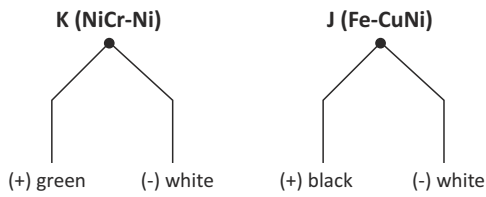

ORDERING

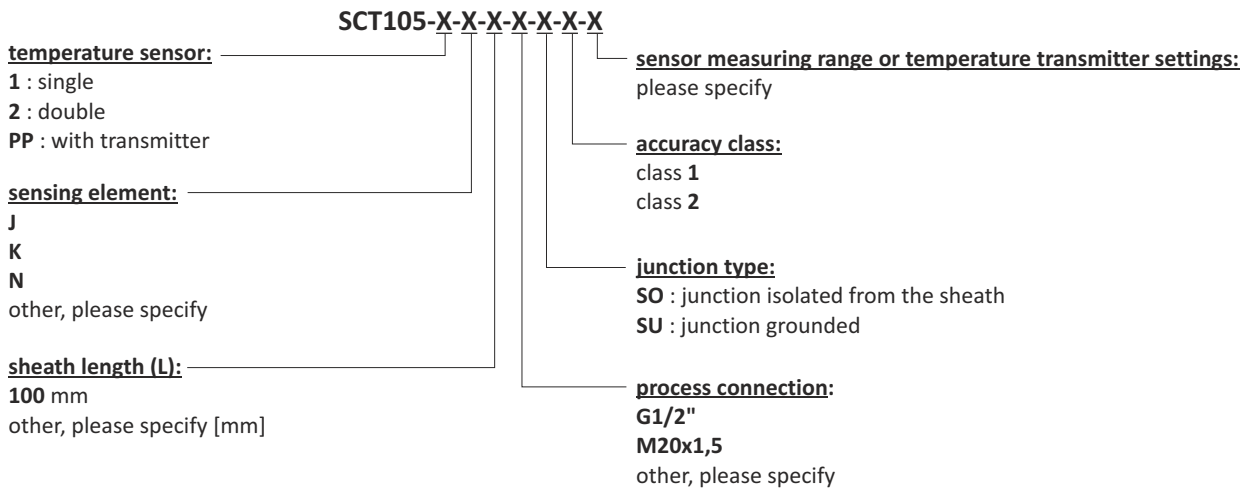

Ordering example:

SCT105-1-K-100-G1/2"-SO-2-100°C

Single TC temperature sensor, K thermocouple, 2 tolerance class, process connection G1/2", sheath length L=100 mm, hot junction isolated from the sheath, sensor measuring range 100°C.

